

**MODEL:  
IMB-H110**

**microATX Motherboard Supports 6th Generation LGA1151 Intel® Core™ i7/i5/i3, Pentium® or Celeron® CPU, Intel® H110 Chipset, DDR4, VGA, DVI-I, LVDS, iDP, Dual GbE LAN, USB 3.0, SATA 6Gb/s, 12 COM Ports, 12 USB Ports, HD Audio and RoHS**

## **User Manual**

# Revision

---

Date	Version	Changes
August 23, 2016	1.00	Initial release

# Copyright

---

## **COPYRIGHT NOTICE**

The information in this document is subject to change without prior notice in order to improve reliability, design and function and does not represent a commitment on the part of the manufacturer.

In no event will the manufacturer be liable for direct, indirect, special, incidental, or consequential damages arising out of the use or inability to use the product or documentation, even if advised of the possibility of such damages.

This document contains proprietary information protected by copyright. All rights are reserved. No part of this manual may be reproduced by any mechanical, electronic, or other means in any form without prior written permission of the manufacturer.

## **TRADEMARKS**

All registered trademarks and product names mentioned herein are used for identification purposes only and may be trademarks and/or registered trademarks of their respective owners.

# Manual Conventions

---



## **WARNING**

Warnings appear where overlooked details may cause damage to the equipment or result in personal injury. Warnings should be taken seriously.



## **CAUTION**

Cautionary messages should be heeded to help reduce the chance of losing data or damaging the product.



## **NOTE**

These messages inform the reader of essential but non-critical information. These messages should be read carefully as any directions or instructions contained therein can help avoid making mistakes.



## **HOT SURFACE**

This symbol indicates a hot surface that should not be touched without taking care.

# Table of Contents

<b>1 INTRODUCTION.....</b>	<b>1</b>
1.1 INTRODUCTION.....	2
1.2 FEATURES.....	3
1.3 CONNECTORS.....	4
1.4 DIMENSIONS.....	5
1.5 DATA FLOW.....	6
1.6 TECHNICAL SPECIFICATIONS.....	7
<b>2 PACKING LIST.....</b>	<b>10</b>
2.1 ANTI-STATIC PRECAUTIONS.....	11
2.2 UNPACKING PRECAUTIONS.....	11
2.3 PACKING LIST.....	12
2.4 OPTIONAL ITEMS.....	13
<b>3 CONNECTORS.....</b>	<b>15</b>
3.1 PERIPHERAL INTERFACE CONNECTORS.....	16
3.1.1 <i>IMB-H110 Layout</i> .....	16
3.1.2 <i>Peripheral Interface Connectors</i> .....	17
3.1.3 <i>External Interface Panel Connectors</i> .....	18
3.2 INTERNAL PERIPHERAL CONNECTORS.....	19
3.2.1 <i>+12V ATX Power Connector</i> .....	19
3.2.2 <i>Additional Power Connector</i> .....	19
3.2.3 <i>ATX Power Connector</i> .....	20
3.2.4 <i>Audio Connector</i> .....	22
3.2.5 <i>Backlight Inverter Connector</i> .....	23
3.2.6 <i>Battery Connector</i> .....	24
3.2.7 <i>Chassis Intrusion Connector</i> .....	25
3.2.8 <i>DDR4 DIMM Sockets</i> .....	25
3.2.9 <i>Digital I/O Connector</i> .....	26
3.2.10 <i>EC Debug Connector</i> .....	27

3.2.11 Fan Connector (CPU).....	28
3.2.12 Fan Connector (System) .....	29
3.2.13 Front Panel Connector .....	30
3.2.14 $\text{PC}$ Connector .....	31
3.2.15 Internal DisplayPort Connector .....	32
3.2.16 Keyboard and Mouse Connector .....	33
3.2.17 LAN LED Connectors .....	34
3.2.18 LVDS Connector .....	35
3.2.19 Parallel Port Connector .....	36
3.2.20 PCI Slots .....	37
3.2.21 PCIe x1 Slot .....	38
3.2.22 PCIe x16 Slot .....	39
3.2.23 PCIe Mini Slot.....	39
3.2.24 Power Button .....	41
3.2.25 RS-232 Serial Port Connectors.....	42
3.2.26 RS-232/422/485 Serial Port Connectors .....	43
3.2.27 SATA 6Gb/s Drive Connector .....	44
3.2.28 SMBus Connector .....	46
3.2.29 SPI Flash Connector.....	47
3.2.30 SPI Flash Connector, EC .....	48
3.2.31 TPM Connector.....	49
3.2.32 USB 2.0 Connector .....	50
3.3 EXTERNAL PERIPHERAL INTERFACE CONNECTOR PANEL .....	51
3.3.1 Audio Connector .....	51
3.3.2 Ethernet and USB 3.0 Connectors .....	52
3.3.3 USB 2.0 Connectors.....	53
3.3.4 VGA and DVI-I Connectors .....	54
<b>4 INSTALLATION .....</b>	<b>56</b>
4.1 ANTI-STATIC PRECAUTIONS .....	57
4.2 INSTALLATION CONSIDERATIONS.....	57
4.3 SOCKET LGA1151 CPU INSTALLATION .....	59
4.4 SOCKET LGA1151 COOLING KIT INSTALLATION .....	62
4.5 DIMM INSTALLATION .....	64
4.6 FULL-SIZE PCIe MINI CARD INSTALLATION .....	65

## IMB-H110 microATX Motherboard

4.7 HALF-SIZE PCIe MINI CARD INSTALLATION.....	66
4.8 SYSTEM CONFIGURATION.....	69
4.8.1 AT/ATX Power Mode Setting .....	69
4.8.2 Clear CMOS Button.....	69
4.8.3 DVI/CRT Selection Switch .....	70
4.8.4 Flash Descriptor Security Override Jumper.....	71
4.8.5 LVDS Panel Resolution Selection Switch .....	72
4.8.6 LVDS Voltage Selection Jumper.....	73
4.8.7 LVDS/iDP Selection Switch .....	74
4.8.8 USB Power Selection .....	75
4.9 INTERNAL PERIPHERAL DEVICE CONNECTIONS.....	75
4.9.1 SATA Drive Connection .....	75
4.10 ADDING USB 3.0 DRIVERS TO A WINDOWS 7 INSTALLATION IMAGE .....	77
4.11 DRIVER INSTALLATION.....	79
<b>5 BIOS.....</b>	<b>81</b>
5.1 INTRODUCTION.....	82
5.1.1 Starting Setup.....	82
5.1.2 Using Setup .....	82
5.1.3 Getting Help.....	83
5.1.4 Unable to Reboot after Configuration Changes .....	83
5.1.5 BIOS Menu Bar.....	83
5.2 MAIN.....	84
5.3 ADVANCED.....	85
5.3.1 Trusted Computing.....	86
5.3.2 ACPI Settings .....	87
5.3.3 Super IO Configuration .....	88
5.3.3.1 Serial Port 1 ~ 6 Configuration.....	89
5.3.3.2 Serial Port 1 Configuration .....	89
5.3.3.3 Serial Port 2 Configuration .....	90
5.3.3.4 Serial Port 3 Configuration .....	91
5.3.3.5 Parallel Port Configuration .....	95
5.3.4 F81866SEC Super IO Configuration .....	97
5.3.4.1 Serial Port 7~12 Configuration.....	97
5.3.5 iWDD H/W Monitor.....	98

5.3.5.1 Smart Fan Mode Configuration .....	99
5.3.6 RTC Wake Settings .....	100
5.3.7 Serial Port Console Redirection .....	102
5.3.7.1 Legacy Console Redirection Settings .....	105
5.3.8 CPU Configuration .....	105
5.3.9 SATA Configuration.....	107
5.3.10 NVMe Configuration.....	108
5.3.11 USB Configuration.....	109
5.3.12 iEi Feature .....	110
5.4 CHIPSET .....	111
5.4.1 System Agent (SA) Configuration .....	112
5.4.1.1 Graphics Configuration.....	113
5.4.1.2 PEG Port Configuration.....	115
5.4.1.3 Memory Configuration .....	116
5.4.2 PCH-IO Configuration .....	117
5.4.2.1 PCI Express Configuration .....	119
5.4.2.2 HD Audio Configuration.....	121
5.5 SECURITY.....	122
5.6 BOOT.....	123
5.7 SAVE & EXIT .....	125
<b>A REGULATORY COMPLIANCE .....</b>	<b>126</b>
<b>B PRODUCT DISPOSAL .....</b>	<b>128</b>
<b>C BIOS OPTIONS .....</b>	<b>130</b>
<b>D TERMINOLOGY .....</b>	<b>134</b>
<b>E DIGITAL I/O INTERFACE .....</b>	<b>138</b>
E.1 INTRODUCTION .....	139
E.2 ASSEMBLY LANGUAGE SAMPLE 1 .....	140
E.3 ASSEMBLY LANGUAGE SAMPLE 2 .....	140
<b>F WATCHDOG TIMER.....</b>	<b>141</b>
<b>G HAZARDOUS MATERIALS DISCLOSURE .....</b>	<b>144</b>



# List of Figures

Figure 1-1: IMB-H110.....	2
Figure 1-2: Connectors .....	4
Figure 1-3: IMB-H110 Dimensions (mm) .....	5
Figure 1-4: Data Flow Diagram.....	6
Figure 3-1: Peripheral Interface Connectors .....	16
Figure 3-2: +12V ATX Power Connector Pinout Location .....	19
Figure 3-3: Additional Power Connector Location.....	20
Figure 3-4: ATX Power Connector Location .....	21
Figure 3-5: Audio Connector Location .....	22
Figure 3-6: Backlight Inverter Connector Location.....	23
Figure 3-7: Battery Connector Location.....	24
Figure 3-8: Chassis Intrusion Connector Location.....	25
Figure 3-9: DDR4 DIMM Socket Locations .....	26
Figure 3-10: Digital I/O Connector Location .....	26
Figure 3-11: EC Debug Connector Location.....	27
Figure 3-12: CPU Fan Connector Location .....	28
Figure 3-13: System Fan Connector Location.....	29
Figure 3-14: Front Panel Connector Location .....	30
Figure 3-15: I <sup>2</sup> C Connector Location .....	31
Figure 3-16: Internal DisplayPort Connector Location .....	32
Figure 3-17: Keyboard and Mouse Connector Location.....	33
Figure 3-18: LAN LED Connector Locations .....	34
Figure 3-19: LVDS Connector Location.....	35
Figure 3-20: Parallel Port Connector Location .....	37
Figure 3-21: PCI Slot Locations .....	38
Figure 3-22: PCIe x1 Slot Location .....	38
Figure 3-23: PCIe x16 Slot Location .....	39
Figure 3-24: PCIe Mini Slot Location .....	40
Figure 3-25: Power Button Location.....	41
Figure 3-26: RS-232 Serial Port Connector Locations.....	42

Figure 3-27: RS-232/422/485 Serial Port Connector Locations.....	43
Figure 3-28: SATA 6Gb/s Drive Connector Locations .....	45
Figure 3-29: SMBus Connector Location .....	46
Figure 3-30: SPI Flash Connector Location.....	47
Figure 3-31: SPI EC Flash Connector Location.....	48
Figure 3-32: TPM Connector Location.....	49
Figure 3-33: USB 2.0 Connector Locations .....	50
Figure 3-34: External Peripheral Interface Connector .....	51
Figure 3-35: Audio Connector .....	52
Figure 3-36: LAN Connector .....	53
Figure 3-37: DVI-I Connector .....	55
Figure 3-38: VGA Connector .....	55
Figure 4-1: Disengage the CPU Socket Load Lever.....	59
Figure 4-2: Remove Protective Cover.....	60
Figure 4-3: Insert the Socket LGA1151 CPU.....	61
Figure 4-4: Close the Socket LGA1151 .....	61
Figure 4-5: Cooling Kit Support Bracket.....	63
Figure 4-6: DIMM Installation.....	64
Figure 4-7: Removing the Retention Screw .....	65
Figure 4-8: Inserting the Full-size PCIe Mini Card into the Slot at an Angle .....	65
Figure 4-9: Securing the Full-size PCIe Mini Card .....	66
Figure 4-10: Removing the Standoff.....	67
Figure 4-11: Installing the Standoff .....	67
Figure 4-12: Inserting the Half-size PCIe Mini Card into the Slot at an Angle.....	68
Figure 4-13: Securing the Half-size PCIe Mini Card .....	68
Figure 4-14: AT/ATX Power Mode Switch Location .....	69
Figure 4-15: Clear CMOS Button Location.....	70
Figure 4-16: DVI/CRT Selection Switch Location .....	70
Figure 4-17: Flash Descriptor Security Override Jumper Location .....	71
Figure 4-18: LVDS Panel Resolution Selection Switch Location .....	72
Figure 4-19: LVDS Voltage Selection Jumper Location .....	73
Figure 4-20: LVDS/iDP Selection Switch Location.....	74
Figure 4-21: SATA Drive Cable Connection.....	76
Figure 4-22: SATA Power Drive Connection.....	77
Figure 4-23: Windows 7 USB 3.0 Creator Utility.....	78

## IMB-H110 microATX Motherboard

Figure 4-24: Update Process is Complete .....79

# List of Tables

---

Table 1-1: IMB-H110 Specifications .....	9
Table 2-1: Packing List.....	12
Table 2-2: Optional Items .....	14
Table 3-1: Peripheral Interface Connectors .....	18
Table 3-2: External Peripheral Connectors .....	18
Table 3-3: +12V ATX Power Connector Pinouts .....	19
Table 3-4: Additional Power Connector Pinouts .....	20
Table 3-5: ATX Power Connector Pinouts .....	21
Table 3-6: Audio Connector Pinouts .....	22
Table 3-7: Backlight Inverter Connector Pinouts .....	23
Table 3-8: Chassis Intrusion Connector Pinouts .....	25
Table 3-9: Digital I/O Connector Pinouts.....	27
Table 3-10: EC Debug Connector Pinouts .....	28
Table 3-11: CPU Fan Connector Pinouts .....	29
Table 3-12: System Fan Connector Pinouts .....	29
Table 3-13: Front Panel Connector Pinouts.....	30
Table 3-14: I <sup>2</sup> C Connector Pinouts.....	31
Table 3-15: Internal DisplayPort Connector Pinouts .....	33
Table 3-16: Keyboard and Mouse Connector Pinouts .....	34
Table 3-17: LAN LED Connector Pinouts .....	35
Table 3-18: LVDS Connector Pinouts .....	36
Table 3-19: Parallel Port Connector Pinouts .....	37
Table 3-20: PCIe Mini Slot Pinouts.....	41
Table 3-21: RS-232 Serial Port Connector Pinouts .....	42
Table 3-22: RS-232/422/485 Serial Port Connector Pinouts .....	44
Table 3-23: DB-9 RS-232/422/485 Pinouts .....	44
Table 3-24: SATA 6Gb/s Drive Connector Pinouts.....	45
Table 3-25: SMBus Connector Pinouts .....	46
Table 3-26: SPI Flash Connector Pinouts .....	47
Table 3-27: SPI EC Flash Connector Pinouts .....	48

## IMB-H110 microATX Motherboard

Table 3-28: TPM Connector Pinouts .....	49
Table 3-29: USB 2.0 Connector Pinouts .....	50
Table 3-30: USB 3.0 Port Pinouts .....	52
Table 3-31: LAN Pinouts .....	53
Table 3-32: USB 2.0 Port Pinouts .....	53
Table 3-33: DVI-I Connector Pinouts .....	54
Table 3-34: VGA Connector Pinouts .....	55
Table 4-1: AT/ATX Power Mode Switch Settings .....	69
Table 4-2: DVI/CRT Selection Switch Settings .....	70
Table 4-3: Flash Descriptor Security Override Jumper Settings .....	71
Table 4-4: LVDS Panel Resolution Selection .....	72
Table 4-5: LVDS Voltage Selection Jumper Settings .....	73
Table 4-6: LVDS/iDP Selection Switch Settings .....	74
Table 4-7: BIOS Options and Configured USB Ports .....	75
Table 4-8: USB Power Source Setup .....	75
Table 5-1: BIOS Navigation Keys .....	83
Table 5-2: BIOS Options and Configured USB Ports .....	118

# BIOS Menus

---

BIOS Menu 1: Main .....	84
BIOS Menu 2: Advanced .....	85
BIOS Menu 3: Trusted Computing .....	86
BIOS Menu 4: ACPI Configuration .....	87
BIOS Menu 5: Super IO Configuration.....	88
BIOS Menu 6: Serial Port 1 ~ 6 Configuration Menu.....	89
BIOS Menu 7: Parallel Port Configuration Menu .....	95
BIOS Menu 8: F81866SEC Super IO Configuration.....	97
BIOS Menu 9: Serial Port 7~12 Configuration Menu.....	97
BIOS Menu 10: iWDD H/W Monitor .....	98
BIOS Menu 11: Smart Fan Mode Configuration .....	99
BIOS Menu 12: RTC Wake Settings .....	100
BIOS Menu 13: Serial Port Console Redirection .....	102
BIOS Menu 14: Legacy Console Redirection Settings .....	105
BIOS Menu 15: CPU Configuration .....	106
BIOS Menu 16: SATA Configuration .....	107
BIOS Menu 17: NVMe Configuration.....	108
BIOS Menu 18: USB Configuration .....	109
BIOS Menu 19: iEi Feature .....	110
BIOS Menu 20: Chipset .....	111
BIOS Menu 21: System Agent (SA) Configuration .....	112
BIOS Menu 22: Graphics Configuration .....	113
BIOS Menu 23: PEG Port Configuration.....	115
BIOS Menu 24: Memory Configuration.....	116
BIOS Menu 25: PCH-IO Configuration .....	117
BIOS Menu 26: PCI Express Configuration .....	119
BIOS Menu 27: MPCIE1 Slot.....	119
BIOS Menu 28: HD Audio Configuration .....	121
BIOS Menu 29: Security .....	122
BIOS Menu 30: Boot .....	123

## IMB-H110 microATX Motherboard

BIOS Menu 31: Save & Exit.....	125
--------------------------------	-----

Chapter

1

# Introduction

---



## 1.1 Introduction

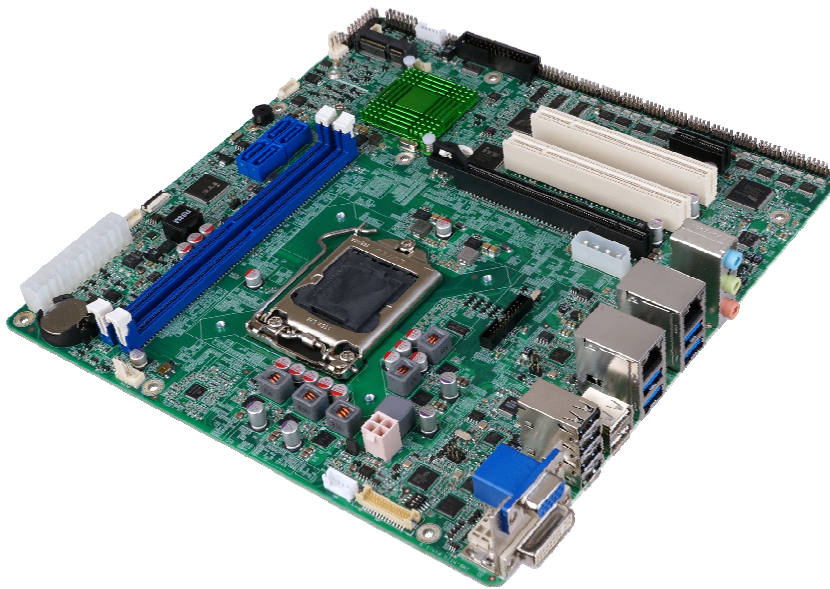

**Figure 1-1: IMB-H110**

The IMB-H110 is a microATX motherboard. It accepts a Socket LGA1151 Intel® Core™ i7/i5/i3, Pentium® or Celeron® processor and supports two 288-pin 2133 MHz dual-channel DDR4 DIMM modules up to 64 GB.

The IMB-H110 provides two GbE interfaces through the Realtek RTL8111GN controllers. The integrated Intel® H110 chipset supports four SATA 6Gb/s drives. In addition, the IMB-H110 includes VGA, DVI-I and LVDS/iDP interfaces for dual independent display.

Expansion and I/O include one PCIe x16 slot, one PCIe x1 slot, two PCI slots, one PCIe Mini slot, four USB 3.0 on the rear panel, six USB 2.0 on the rear panel, two USB 2.0 by pin headers, ten RS-232 and two RS-232/422/485. High Definition Audio (HDA) support ensures HDA devices can be easily implemented on the IMB-H110.

## IMB-H110 microATX Motherboard

### 1.2 Features

Some of the IMB-H110 motherboard features are listed below:

- microATX form factor
- 6th generation LGA1151 Intel® Core™ i7/i5/i3, Pentium® or Celeron® processor supported
- Intel® H110 chipset
- Two 288-pin 2133 MHz dual-channel unbuffered DDR4 DIMMs supported (system max. 32 GB)
- Two GbE connectors via Realtek RTL8111GN controllers
- Dual independent display by VGA, DVI-I and LVDS/iDP interfaces
- Four SATA 6Gb/s connectors
- One PCIe x16 slot
- One PCIe x1 slot
- Two PCI slots
- One full-size/half-size PCIe Mini slot
- Four USB 3.0 ports on the rear I/O
- Six USB 2.0 ports on the rear I/O
- Two USB 2.0 ports via internal pin headers
- Ten RS-232 serial ports
- Two RS-232/422/485 serial ports
- TPM V1.2 hardware security function supported by TPM module
- High Definition Audio
- RoHS compliant

### 1.3 Connectors

The connectors on the IMB-H110 are shown in the figure below.

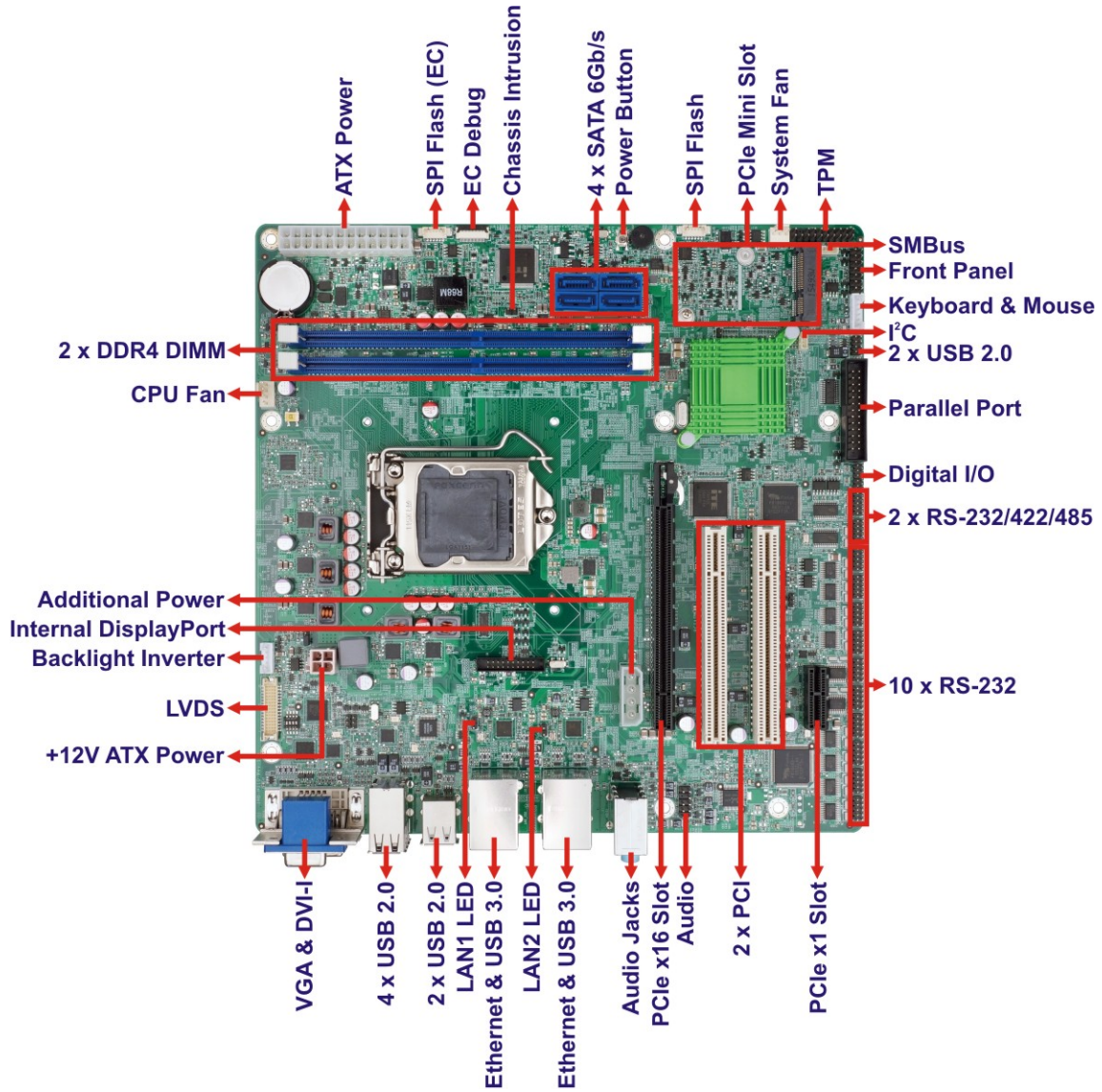

**Figure 1-2: Connectors**

## IMB-H110 microATX Motherboard

### 1.4 Dimensions

The main dimensions of the IMB-H110 are shown in the diagram below.

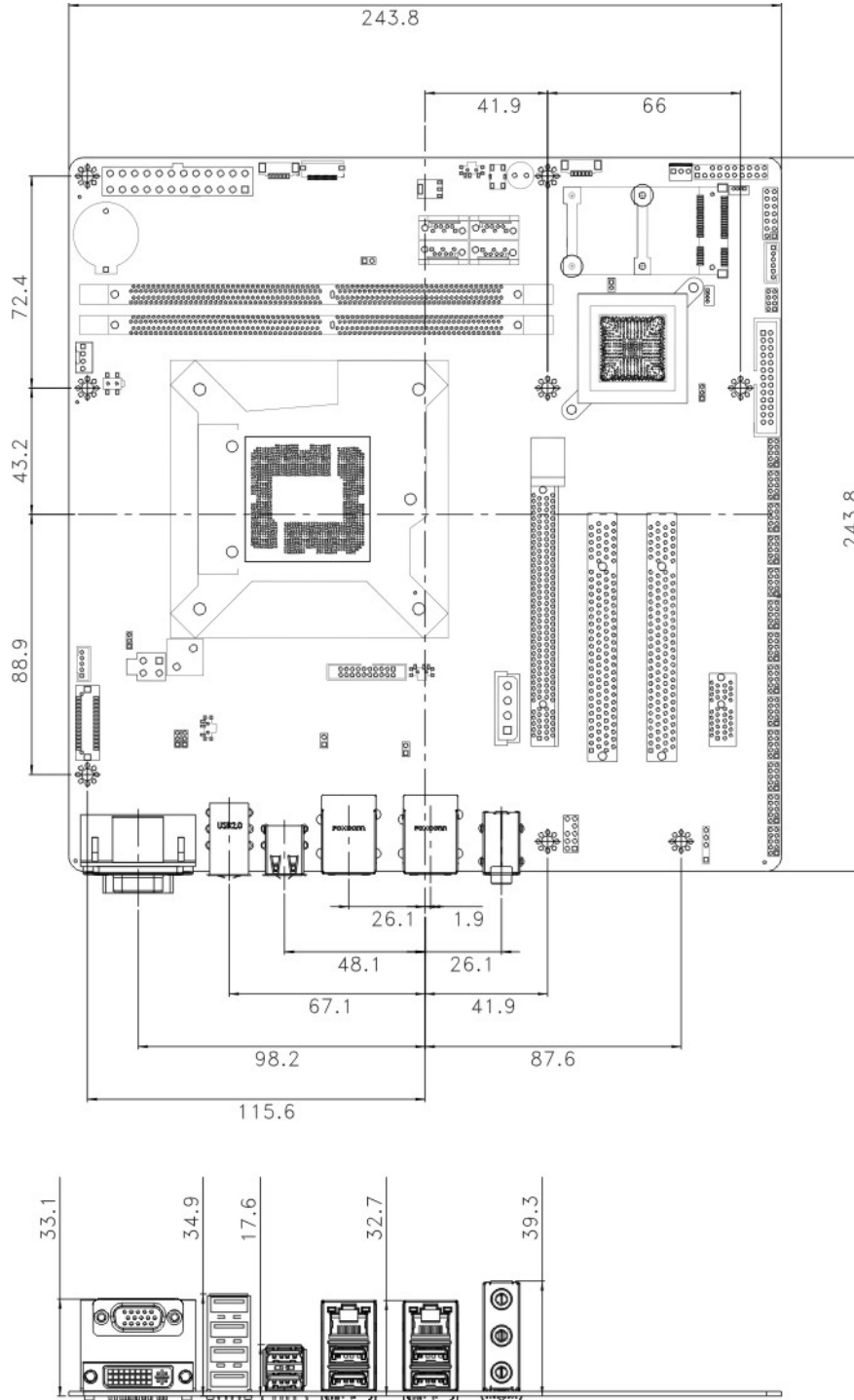

Figure 1-3: IMB-H110 Dimensions (mm)

### 1.5 Data Flow

Figure 1-4 shows the data flow between the system chipset, the CPU and other components installed on the motherboard.

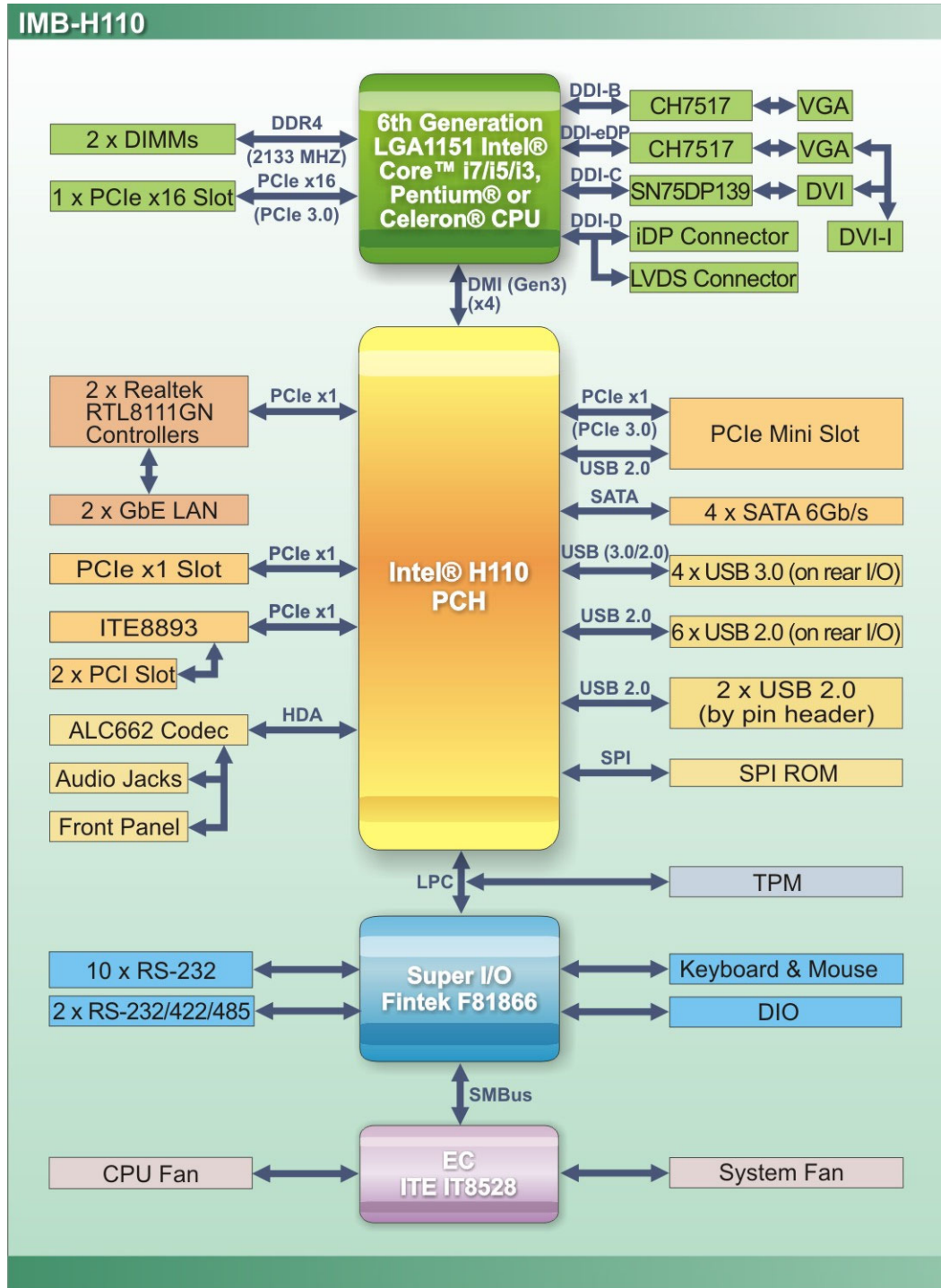

Figure 1-4: Data Flow Diagram

## IMB-H110 microATX Motherboard

### 1.6 Technical Specifications

The IMB-H110 technical specifications are listed below.

Specification/Model	IMB-H110
<b>Form Factor</b>	microATX
<b>CPU Supported</b>	6th generation LGA1151 Intel® Core™ i7/i5/i3, Pentium® or Celeron® CPU
<b>PCH</b>	Intel® H110
<b>Memory</b>	Two 288-pin 2133 MHz dual-channel unbuffered DDR4 SDRAM DIMMs supported (system max. 64 GB)
<b>Graphics Engine</b>	Intel® HD Graphics Gen9 engine with 16 low-power execution units, supporting DX2015, OpenGL 5.x, OpenCL 2.x and ES 2.0
<b>Display Output</b>	Supports dual independent display One VGA (Chrontel CH7517) One DVI-I (TI SN75DP139, Chrontel CH7517) One LVDS (Chrontel CH7511) One iDP interface for HDMI, LVDS, VGA, DVI and DisplayPort
<b>Ethernet Controllers</b>	Dual Realtek RTL 8111GN GbE controller
<b>Audio</b>	Realtek ALC662 HD Audio codec supports 5.1 channels
<b>BIOS</b>	AMI UEFI BIOS
<b>Super I/O Controller</b>	Fintek F81866
<b>Watchdog Timer</b>	Software programmable supports 1~255 sec. system reset
<b>Expansions</b>	One PCIe x16 slot (Gen3) One PCIe x1 slot (Gen2) Two PCI slots One full-size/half-size PCIe Mini card slot

I/O Interface Connectors	
<b>Audio Connectors</b>	Line-in, line-out and mic-in audio jacks on rear panel One internal front panel audio connector (10-pin header)
<b>Chassis Intrusion</b>	One 2-pin header
<b>Digital I/O</b>	8-bit digital I/O
<b>Ethernet</b>	Two RJ-45 GbE ports
<b>Fan</b>	One 4-pin CPU smart fan connector One 3-pin system smart fan connector
<b>Front Panel</b>	One 14-pin header (power LED, HDD LED, speaker, power button, reset button)
<b>I<sup>2</sup>C</b>	One 4-pin wafer connector
<b>Internal DisplayPort</b>	One 20-pin box header
<b>Keyboard and Mouse</b>	One internal keyboard and mouse connector (6-pin wafer)
<b>LAN LED</b>	Two 2-pin headers for LAN1 LED and LAN2 LED
<b>Parallel Port</b>	One parallel port via internal 26-pin box header
<b>Serial ATA</b>	Four SATA 6Gb/s connectors
<b>Serial Ports</b>	Ten RS-232 via internal 10-pin headers Two RS-232/422/485 via internal 10-pin headers
<b>SMBus</b>	One 4-pin wafer connector
<b>TPM</b>	One via 20-pin header
<b>USB 2.0</b>	Six USB 2.0 ports on rear panel Two USB 2.0 ports via internal pin headers
<b>USB 3.0</b>	Four USB 3.0 ports on rear panel <b>* The Windows® 7 installation media does not include native driver support for USB 3.0. In order to use the USB keyboard or mouse connected to a USB 3.0 port during OS installation, the user has to update the Windows® 7 installation image so that it contains USB 3.0 drivers. Please refer to Section 4.10 for detailed installation procedures.</b>

## IMB-H110 microATX Motherboard

Environmental and Power Specifications	
<b>Power Supply</b>	AT/ATX power support
<b>Power Consumption</b>	3.3V@0.93A, 5V@2.99A, 12V@6.88A, 5VSB@0.02A (4.0 GHz Intel® Core™ i7-6700K CPU with two 8 GB 2133 MHz DDR4 memory)
<b>Operating Temperature</b>	-20°C ~ 60°C
<b>Storage Temperature</b>	-30°C ~ 70°C
<b>Operating Humidity</b>	5% ~ 95% (non-condensing)
Physical Specifications	
<b>Dimensions</b>	244 mm x 244 mm
<b>Weight (GW/NW)</b>	1200 g / 700 g

**Table 1-1: IMB-H110 Specifications**



Chapter

2

# Packing List

---

## IMB-H110 microATX Motherboard

### 2.1 Anti-static Precautions

---



#### WARNING!

Static electricity can destroy certain electronics. Make sure to follow the ESD precautions to prevent damage to the product, and injury to the user.

---

Make sure to adhere to the following guidelines:

- **Wear an anti-static wristband:** Wearing an anti-static wristband can prevent electrostatic discharge.
- **Self-grounding:** Touch a grounded conductor every few minutes to discharge any excess static buildup.
- **Use an anti-static pad:** When configuring any circuit board, place it on an anti-static mat.
- **Only handle the edges of the PCB:** Don't touch the surface of the motherboard. Hold the motherboard by the edges when handling.

### 2.2 Unpacking Precautions

When the IMB-H110 is unpacked, please do the following:

- Follow the anti-static guidelines above.
- Make sure the packing box is facing upwards when opening.
- Make sure all the packing list items are present.







## 2.3 Packing List



**NOTE:**

If any of the components listed in the checklist below are missing, do not proceed with the installation. Contact the IEI reseller or vendor the IMB-H110 was purchased from or contact an IEI sales representative directly by sending an email to [sales@ieiworld.com](mailto:sales@ieiworld.com).

The IMB-H110 is shipped with the following components:









Quantity	Item and Part Number	Image
1	IMB-H110 single board computer	
2	SATA cable	
1	I/O shielding	
1	Utility CD	
1	One Key Recovery CD	
1	Quick installation guide	



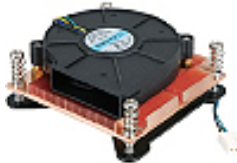

**Table 2-1: Packing List**

## IMB-H110 microATX Motherboard

### 2.4 Optional Items

The following are optional components which may be separately purchased:

Item and Part Number	Image
LPT cable (P/N: 19800-000049-RS)	
PS/2 KB/MS Y-cable with bracket (P/N: 19800-000075-RS)	
RS-232/422/485 cable, 300 mm, p=2.00 mm (P/N: 19800-000112-RS)	
SATA power cable (P/N: 32102-000100-200-RS)	
High-performance LGA1155/LGA1156 cooler kit (1U chassis compatible, 73W) (P/N: CF-1156A-RS-R11)	
High-performance LGA1155/LGA1156 cooler kit (95W) (P/N: CF-1156E-R11)	
DisplayPort to HDMI converter board (for IEI iDP connector) (P/N: DP-HDMI-R10)	
DisplayPort to LVDS converter board (for IEI iDP connector) (P/N: DP-LVDS-R10)	

Item and Part Number	Image
DisplayPort to VGA converter board (for IEI iDP connector) (P/N: DP-VGA-R10)	
DisplayPort to DVI-D converter board (for IEI iDP connector) (P/N: DP-DVI-R10)	
DisplayPort to DisplayPort converter board (for IEI iDP connector) (P/N: DP-DP-R10)	
20-pin Infineon TPM module, software management tool, firmware v3.17 (P/N: TPM-IN01-R11)	

**Table 2-2: Optional Items**

Chapter

**3**

# Connectors

---

### 3.1 Peripheral Interface Connectors

This chapter details all the peripheral interface connectors.

#### 3.1.1 IMB-H110 Layout

The figure below shows all the peripheral interface connectors.

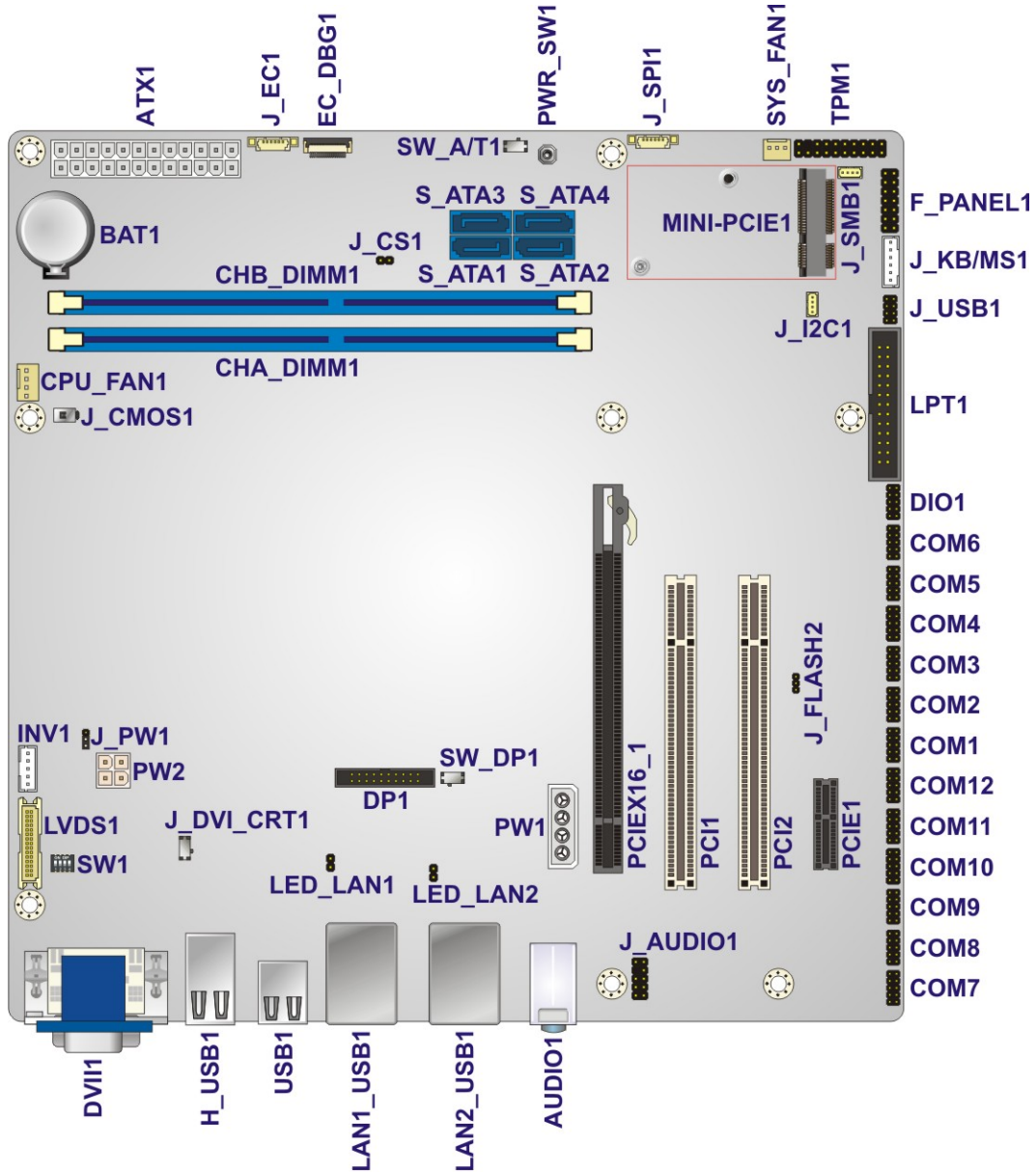

**Figure 3-1: Peripheral Interface Connectors**

## IMB-H110 microATX Motherboard

### 3.1.2 Peripheral Interface Connectors

The table below lists all the connectors on the board.

Connector	Type	Label
+12V ATX power connector	4-pin Molex power connector	PW2
Additional power connector	4-pin connector	PW1
ATX power connector	24-pin connector	ATX1
Audio connector	10-pin header	J_AUDIO1
Backlight inveter connector	5-pin wafer	INV1
Battery connector	Battery holder	BAT1
Chassis intrusion connector	2-pin header	J_CS1
DDR4 DIMM sockets	288-pin DDR4 DIMM socket	CHA_DIMM1, CHB_DIMM1
Digital I/O connector	10-pin header	DIO1
EC debug connector	20-pin wafer	EC_DBG1
Fan connector (CPU)	4-pin wafer	CPU_FAN1
Fan connector (system)	3-pin wafer	SYS_FAN1
Front panel connector	14-pin header	F_PANEL1
I <sup>2</sup> C connector	4-pin wafer	J_I2C1
Internal DisplayPort connector	20-pin box header	DP1
Keyboard and mouse connector	6-pin wafer	J_KB/MS1
LAN LED connectors	2-pin header	LED_LAN1, LED_LAN2
LVDS connector	30-pin crimp	LVDS1
Parallel port connector	26-pin box header	LPT1
PCI slots	PCI slot	PCI1, PCI2
PCIe x1 slot	PCIe x1 slot	PCIE1
PCIe x16 slot	PCIe x16 slot	PCIEX16_1



Connector	Type	Label
PCIe Mini slot	PCIe Mini slot	MINI-PCIE1
Power button	Push button	PWR_SW1
RS-232 serial ports	10-pin header	COM1 ~ COM4, COM7 ~ COM12
RS-232/422/485 serial ports	10-pin header	COM5, COM6
SATA 6Gb/s drive connector	7-pin SATA connector	S_ATA1, S_ATA2, S_ATA3, S_ATA4
SMBus connector	4-pin wafer	J_SMB1
SPI flash connector	6-pin wafer	J_SPI1
SPI flash connector, EC	6-pin wafer	J_EC1
TPM connector	20-pin header	TPM1
USB 2.0 connector	8-pin header	J_USB1

**Table 3-1: Peripheral Interface Connectors**

### 3.1.3 External Interface Panel Connectors

The table below lists the connectors on the external I/O panel.

Connector	Type	Label
Audio connector	Audio jacks	AUDIO1
Ethernet and USB 3.0 ports	RJ-45, USB 3.0	LAN1_USB1, LAN2_USB1
Ethernet ports	RJ-45	LAN1, LAN2
USB 2.0 ports	USB 2.0	USB1, H_USB1
VGA and DVI-I connectors	15-pin female, 24-pin female	VIDEO1

**Table 3-2: External Peripheral Connectors**

## IMB-H110 microATX Motherboard

### 3.2 Internal Peripheral Connectors

The section describes all of the connectors on the IMB-H110.

#### 3.2.1 +12V ATX Power Connector

- CN Label:** CPU12V1
- CN Type:** 4-pin Molex power connector, p=4.2 mm
- CN Location:** See **Figure 3-2**
- CN Pinouts:** See **Table 3-3**

This connector provides power to the CPU.

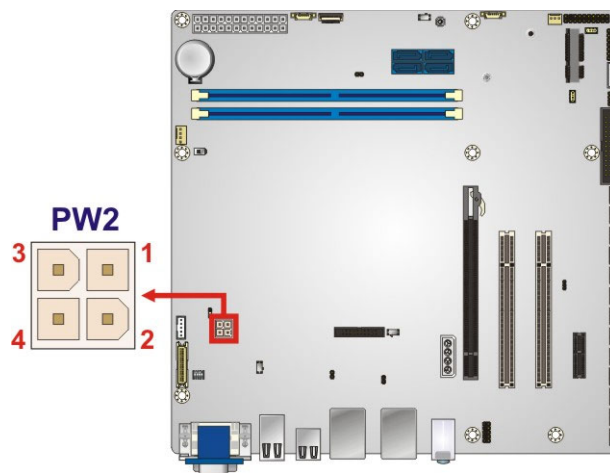

**Figure 3-2: +12V ATX Power Connector Pinout Location**

Pin	Description	Pin	Description
1	GND	2	GND
3	VCC12V	4	VCC12V

**Table 3-3: +12V ATX Power Connector Pinouts**

#### 3.2.2 Additional Power Connector

- CN Label:** PW1
- CN Type:** 4-pin connector, p=5.08 mm
- CN Location:** See **Figure 3-3**
- CN Pinouts:** See **Table 3-4**

The additional power connector provides extra +12V and +5V power to the system.

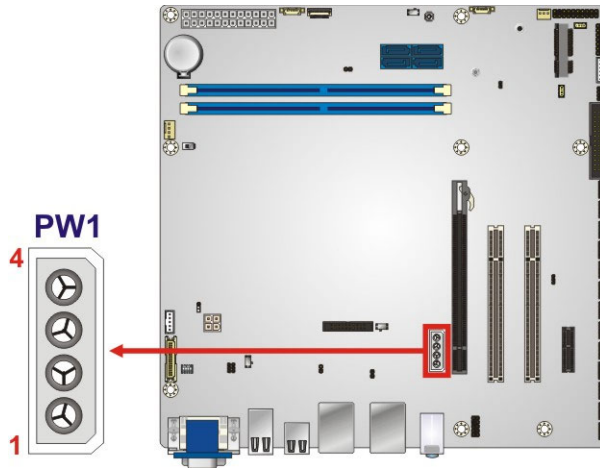

**Figure 3-3: Additional Power Connector Location**

Pin	Description
1	VCC12V
2	GND
3	GND
4	VCC5V

**Table 3-4: Additional Power Connector Pinouts**

### 3.2.3 ATX Power Connector

- CN Label:** ATX1
- CN Type:** 24-pin connector, p=4.2 mm
- CN Location:** See **Figure 3-4**
- CN Pinouts:** See **Table 3-5**

The ATX power connector connects to an ATX power supply.

**IMB-H110 microATX Motherboard**

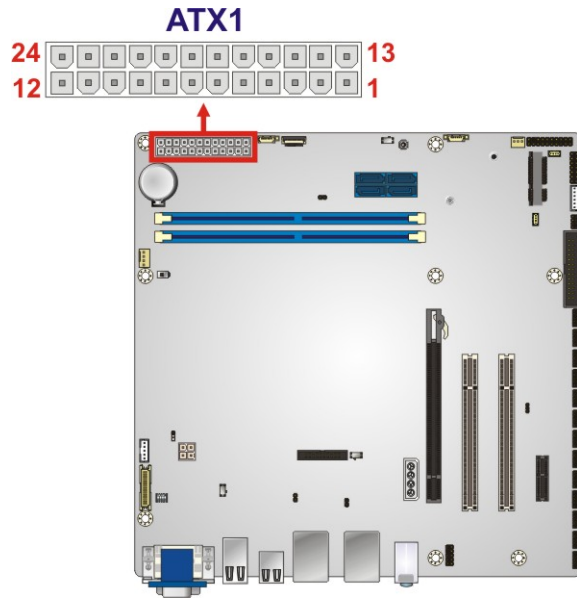

**Figure 3-4: ATX Power Connector Location**

Pin	Description	Pin	Description
1	VCC3V	13	VCC3V
2	VCC3V	14	-VCC12V
3	GND	15	GND
4	VCC5V	16	PS_ON
5	GND	17	GND
6	VCC5V	18	GND
7	GND	19	GND
8	PWR-OK	20	NC
9	SB5V	21	VCC5V
10	VCC12V	22	VCC5V
11	VCC12V	23	VCC5V
12	VCC3V	24	GND

**Table 3-5: ATX Power Connector Pinouts**

**3.2.4 Audio Connector**

- CN Label:** J\_AUDIO1
- CN Type:** 10-pin header, p=2.54 mm
- CN Location:** See **Figure 3-5**
- CN Pinouts:** See **Table 3-6**

This connector connects to speakers, a microphone and an audio input.

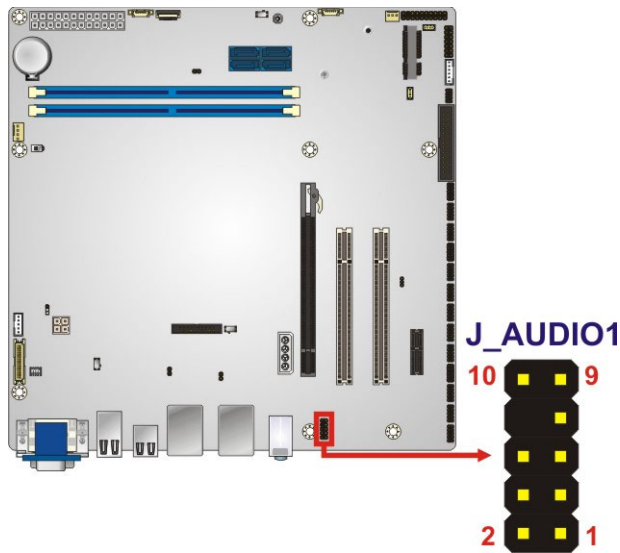

**Figure 3-5: Audio Connector Location**

Pin	Description	Pin	Description
1	MIC2-L	2	GND
3	MIC2-R	4	PRESENCE
5	LINE2-R	6	MIC2-JD
7	SENSE	8	NC
9	LINE2-L	10	LINE2-JD

**Table 3-6: Audio Connector Pinouts**

## IMB-H110 microATX Motherboard

### 3.2.5 Backlight Inverter Connector

- CN Label:** INV1
- CN Type:** 5-pin wafer, p=2.00 mm
- CN Location:** See **Figure 3-6**
- CN Pinouts:** See **Table 3-7**

The backlight inverter connector provides power to an LCD panel.

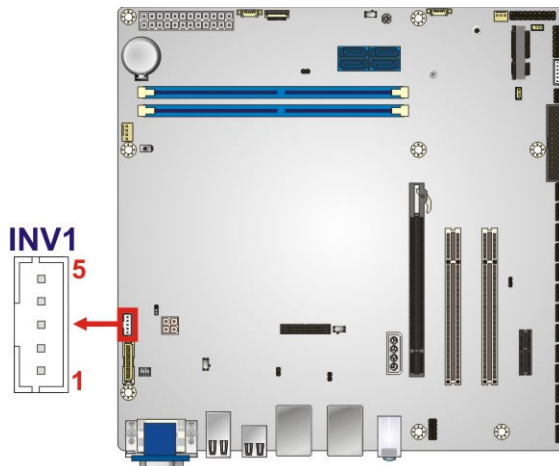

**Figure 3-6: Backlight Inverter Connector Location**

Pin	Description
1	LCD_ADJ
2	GND
3	VCC12V
4	GND
5	BL_ON/OFF

**Table 3-7: Backlight Inverter Connector Pinouts**

### 3.2.6 Battery Connector

**CAUTION:**

Risk of explosion if battery is replaced by an incorrect type. Only certified engineers should replace the on-board battery.

Dispose of used batteries according to instructions and local regulations.

---

<b>CN Label:</b>	<b>BAT1</b>
<b>CN Type:</b>	Battery holder
<b>CN Location:</b>	See <b>Figure 3-7</b>

A system battery is placed in the battery holder. The battery provides power to the system clock to retain the time when power is turned off.

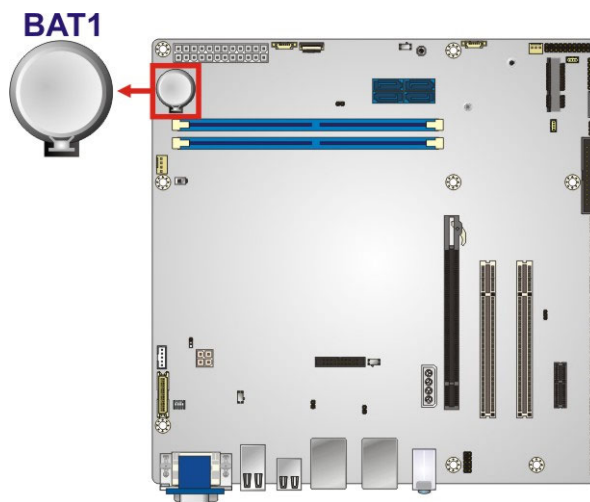

**Figure 3-7: Battery Connector Location**

## IMB-H110 microATX Motherboard

### 3.2.7 Chassis Intrusion Connector

- CN Label:** J\_CS1
- CN Type:** 2-pin header, p=2.54 mm
- CN Location:** See **Figure 3-8**
- CN Pinouts:** See **Table 3-8**

The chassis intrusion connector is for a chassis intrusion detection sensor or switch that detects if a chassis component is removed or replaced.

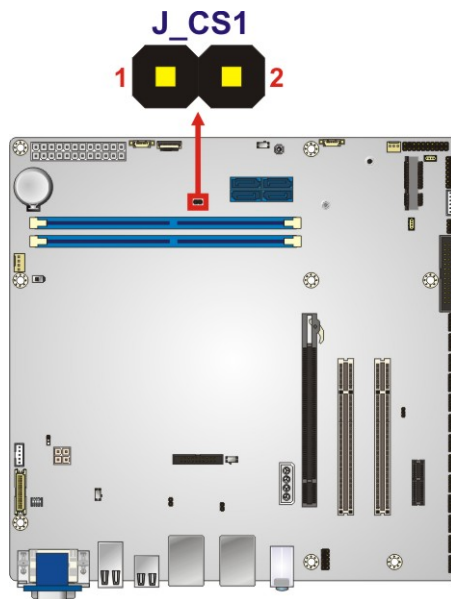

**Figure 3-8: Chassis Intrusion Connector Location**

Pin	Description
1	VCC3V
2	CHASSIS

**Table 3-8: Chassis Intrusion Connector Pinouts**

### 3.2.8 DDR4 DIMM Sockets

- CN Label:** CHA\_DIMM1, CHB\_DIMM1
- CN Type:** 288-pin DDR4 DIMM socket
- CN Location:** See **Figure 3-9**



The DIMM slots are for installing the DDR4 DIMMs.

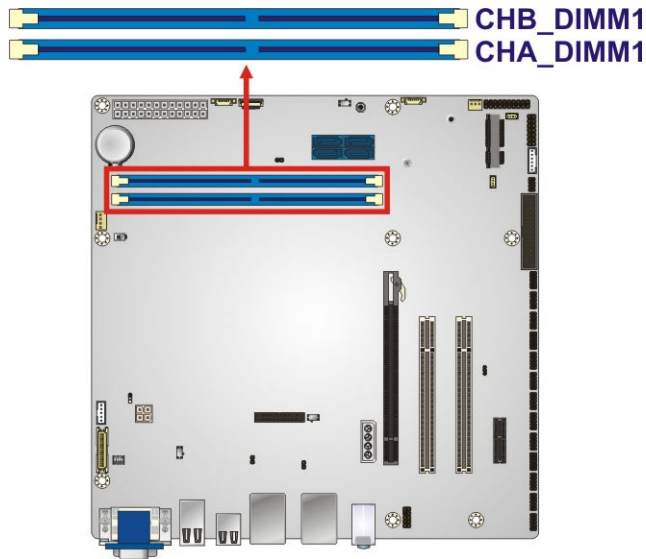
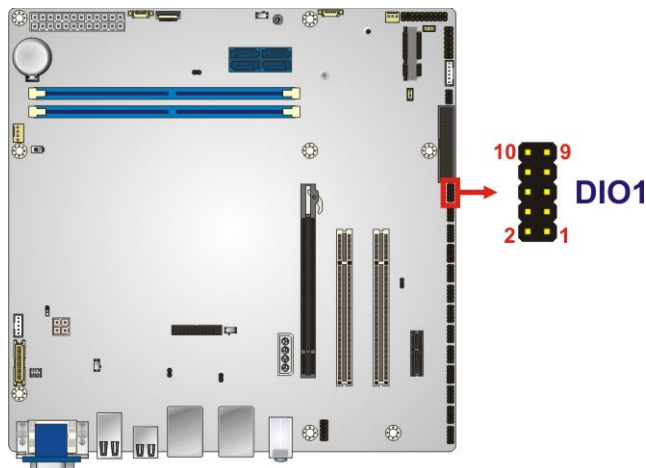

**Figure 3-9: DDR4 DIMM Socket Locations**

### 3.2.9 Digital I/O Connector

- CN Label:** DIO1
- CN Type:** 10-pin header, p=2.00 mm
- CN Location:** See **Figure 3-10**
- CN Pinouts:** See **Table 3-9**

The digital I/O connector provides programmable input and output for external devices.



**Figure 3-10: Digital I/O Connector Location**

## IMB-H110 microATX Motherboard

Pin	Description	Pin	Description
1	GND	2	VCC5V
3	Output 3	4	Output 2
5	Output 1	6	Output 0
7	Input 3	8	Input 2
9	Input 1	10	Input 0

**Table 3-9: Digital I/O Connector Pinouts**

### 3.2.10 EC Debug Connector

- CN Label:** EC\_DBG1
- CN Type:** 20-pin wafer, p=0.5 mm
- CN Location:** See **Figure 3-11**
- CN Pinouts:** See **Table 3-10**

The EC debug connector is used for EC debug.

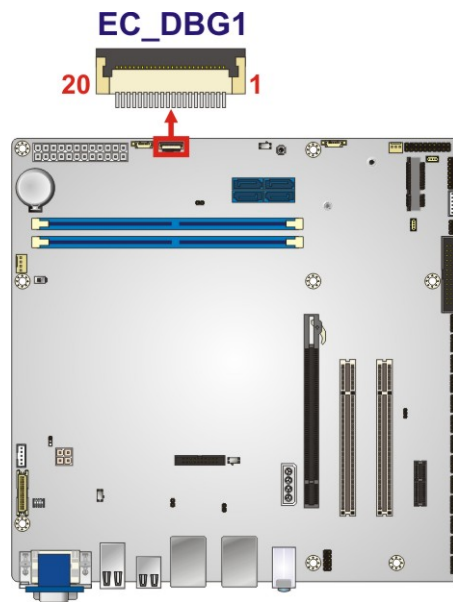

**Figure 3-11: EC Debug Connector Location**

Pin	Description	Pin	Description
1	KS10	11	KS09
2	KS00	12	KS010
3	KS01	13	KS012
4	KS02	14	KS11
5	KS03	15	KS011
6	KS04	16	KS12
7	KS05	17	KS13
8	KS06	18	GND
9	KS07	19	GND
10	KS08	20	GND

**Table 3-10: EC Debug Connector Pinouts**

### 3.2.11 Fan Connector (CPU)

- CN Label:** CPU\_FAN1
- CN Type:** 4-pin wafer, p=2.54 mm
- CN Location:** See **Figure 3-12**
- CN Pinouts:** See **Table 3-11**

The fan connector attaches to a CPU cooling fan.

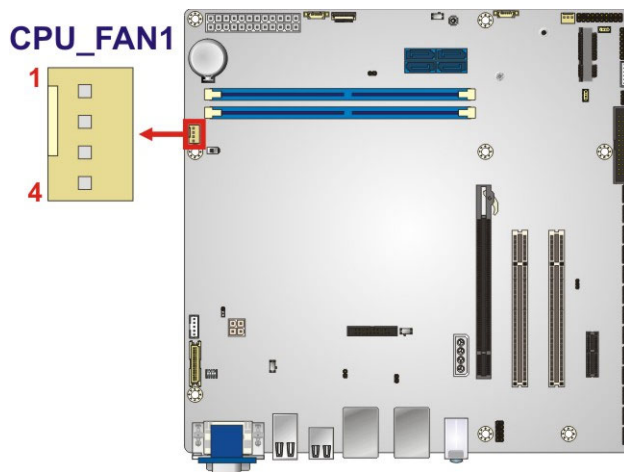

**Figure 3-12: CPU Fan Connector Location**

## IMB-H110 microATX Motherboard

Pin	Description
1	GND
2	VCC12V
3	FANIO
4	PWM

**Table 3-11: CPU Fan Connector Pinouts**

### 3.2.12 Fan Connector (System)

- CN Label:**        **SYS\_FAN1**
- CN Type:**         3-pin wafer, p=2.54 mm
- CN Location:**    See **Figure 3-12**
- CN Pinouts:**     See **Table 3-11**

The fan connector attaches to a system cooling fan.

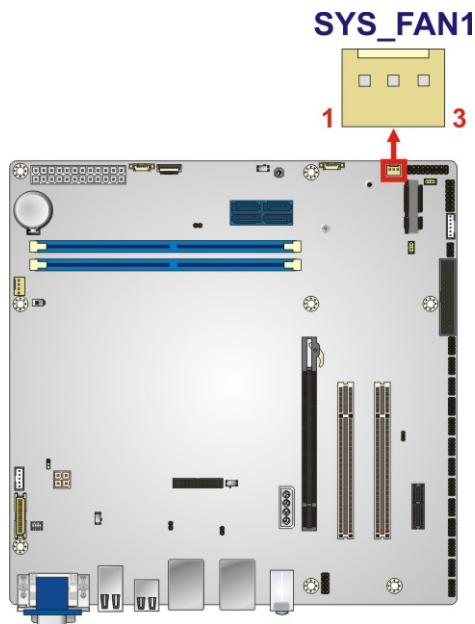

**Figure 3-13: System Fan Connector Location**

Pin	Description
1	FANIO
2	PWM/VCC12V
3	GND

**Table 3-12: System Fan Connector Pinouts**

**3.2.13 Front Panel Connector**

- CN Label:** F\_PANEL1
- CN Type:** 14-pin header, p=2.54 mm
- CN Location:** See **Figure 3-14**
- CN Pinouts:** See **Table 3-13**

The front panel connector connects to the indicator LEDs and buttons on the computer's front panel.

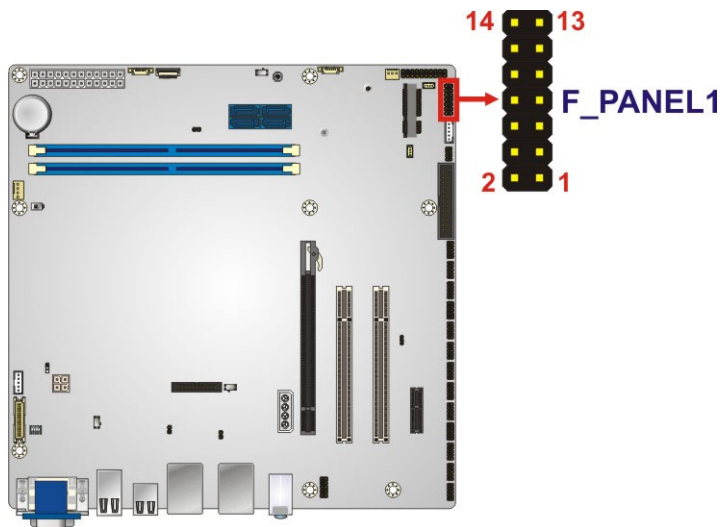

**Figure 3-14: Front Panel Connector Location**

Function	Pin	Description	Function	Pin	Description
Power LED	1	PWR_LED+	Speaker	2	SPKR+
	3	NC		4	NC
	5	PWR_LED-		6	NC
Power Button	7	PWR_BTN+	8	SPKR-	
	9	PWR_BTN-	10	NC	
HDD LED	11	HDD_LED+	Reset	12	RESET+
	13	HDD_LED-		14	RESET-

**Table 3-13: Front Panel Connector Pinouts**

## IMB-H110 microATX Motherboard

### 3.2.14 I<sup>2</sup>C Connector

- CN Label:** J\_I2C1
- CN Type:** 4-pin wafer, p=1.25 mm
- CN Location:** See **Figure 3-15**
- CN Pinouts:** See **Table 3-14**

The I<sup>2</sup>C connector is used to connect I<sup>2</sup>C-bus devices to the motherboard.

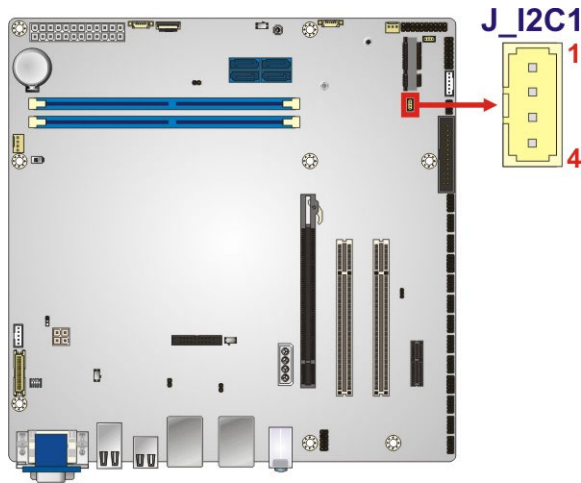

**Figure 3-15: I<sup>2</sup>C Connector Location**

Pin	Description
1	GND
2	I2C_DATA
3	I2C_CLK
4	VCC5V

**Table 3-14: I<sup>2</sup>C Connector Pinouts**

**3.2.15 Internal DisplayPort Connector**



**NOTE:**

The user can select either to use the LVDS connector or the internal DisplayPort connector. Use the LVDS/iDP selection switch to configure the settings. Please refer to **Section 4.8.5** for detailed information.

- CN Label:** DP1
- CN Type:** 20-pin box header, p=2.00 mm
- CN Location:** See **Figure 3-16**
- CN Pinouts:** See **Table 3-15**

The internal DisplayPort connector supports HDMI, LVDS, VGA, DVI and DisplayPort graphics interfaces.

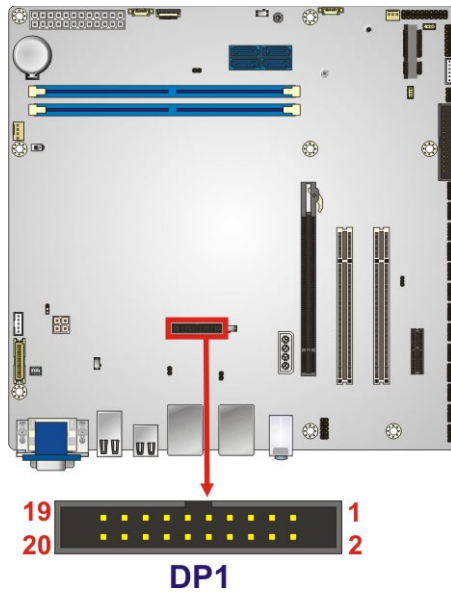

**Figure 3-16: Internal DisplayPort Connector Location**

## IMB-H110 microATX Motherboard

Pin	Description	Pin	Description
1	HPD	2	AUX_P
3	GND	4	AUX_N
5	AUX_DET	6	GND
7	GND	8	LANE2P
9	LANE3P	10	LANE2N
11	LANE3N	12	GND
13	GND	14	LANE0P
15	LANE1P	16	LANE0N
17	LANE1N	18	VCC3V
19	VCC5V	20	NC

**Table 3-15: Internal DisplayPort Connector Pinouts**

### 3.2.16 Keyboard and Mouse Connector

- CN Label:** J\_KB/MS1
- CN Type:** 6-pin wafer, p=2.00 mm
- CN Location:** See **Figure 3-17**
- CN Pinouts:** See **Table 3-16**

The keyboard and mouse connector connects to a PS/2 Y-cable that can be connected to a PS/2 keyboard and mouse.

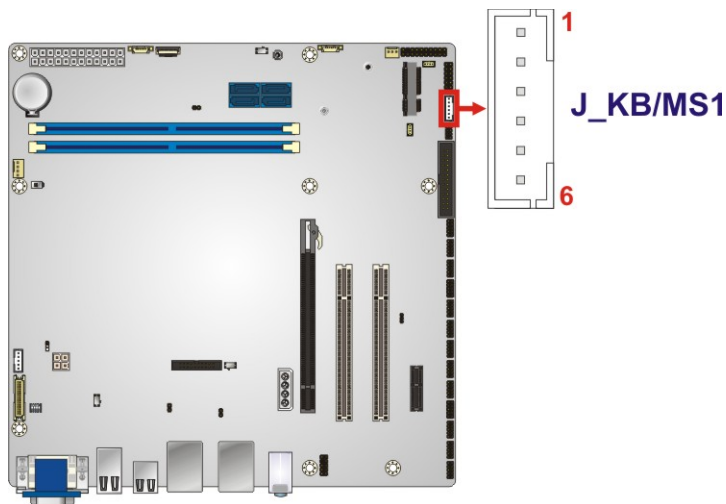

**Figure 3-17: Keyboard and Mouse Connector Location**



Pin	Description
1	VCC5V
2	Mouse Data
3	Mouse Clock
4	Keyboard Data
5	Keyboard Clock
6	GND

**Table 3-16: Keyboard and Mouse Connector Pinouts**

### 3.2.17 LAN LED Connectors

**CN Label:** LED\_LAN1, LED\_LAN2

**CN Type:** 2-pin header, p=2.54 mm

**CN Location:** See **Figure 3-18**

**CN Pinouts:** See **Table 3-17**

The LAN LED connectors are used to connect to the LAN LED indicators on the chassis to indicate users the link activities of the two LAN ports.

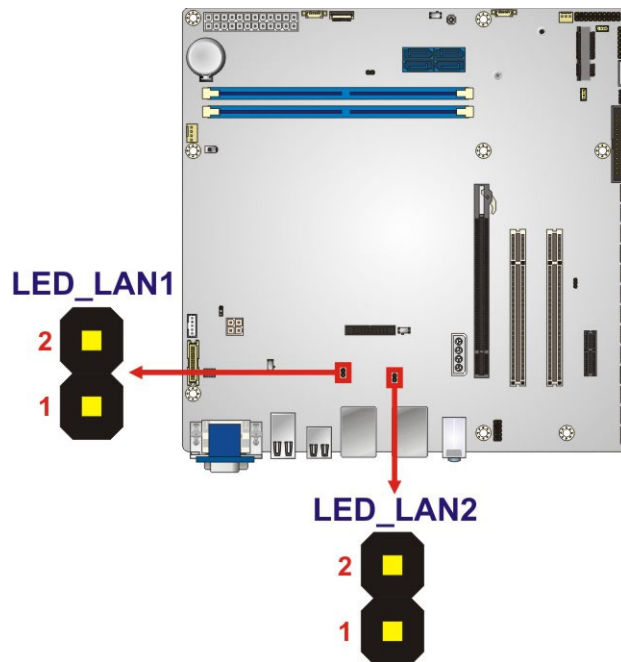

**Figure 3-18: LAN LED Connector Locations**

## IMB-H110 microATX Motherboard

Pin	Description
1	VCC3V
2	ACT

**Table 3-17: LAN LED Connector Pinouts**

### 3.2.18 LVDS Connector



**NOTE:**

The user can select either to use the LVDS connector or the internal DisplayPort connector. Use the LVDS/iDP selection switch to configure the settings. Please refer to **Section 4.8.5** for detailed information.

- CN Label:** LVDS1
- CN Type:** 30-pin crimp, p=1.25 mm
- CN Location:** See **Figure 3-19**
- CN Pinouts:** See **Table 3-18**

The LVDS connector is for an LCD panel to connect to the board.

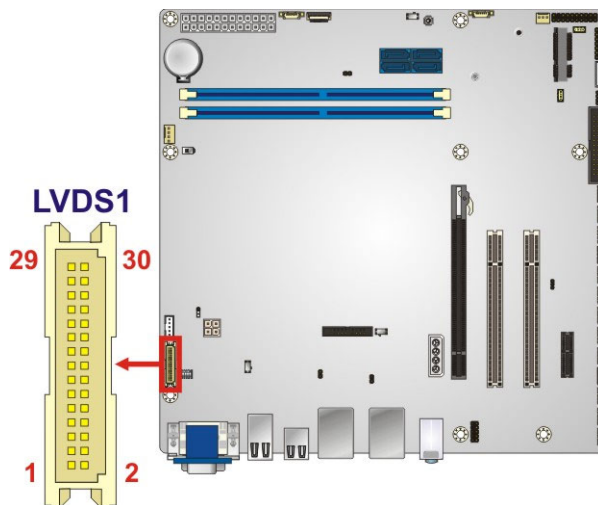

**Figure 3-19: LVDS Connector Location**

Pin	Description	Pin	Description
1	GROUND	2	GROUND
3	LVDS_A_TX0-P	4	LVDS_A_TX0-N
5	LVDS_A_TX1-P	6	LVDS_A_TX1-N
7	LVDS_A_TX2-P	8	LVDS_A_TX2-N
9	LVDS_A_TXCLK-P	10	LVDS_A_TXCLK-N
11	LVDS_A_TX3-P	12	LVDS_A_TX3-N
13	GROUND	14	GROUND
15	LVDS_B_TX0-P	16	LVDS_B_TX0-N
17	LVDS_B_TX1-P	18	LVDS_B_TX1-N
19	LVDS_B_TX2-P	20	LVDS_B_TX2-N
21	LVDS_B_TXCLK-P	22	LVDS_B_TXCLK-N
23	LVDS_B_TX3-P	24	LVDS_B_TX3-N
25	GROUND	26	GROUND
27	+LCD VCC	28	+LCD VCC
29	+LCD VCC	30	+LCD VCC

**Table 3-18: LVDS Connector Pinouts**

### 3.2.19 Parallel Port Connector

- CN Label:** LPT1
- CN Type:** 26-pin box header, p=2.54 mm
- CN Location:** See **Figure 3-20**
- CN Pinouts:** See **Table 3-19**

The parallel port connector connects to a parallel port connector interface or some other parallel port device such as a printer.

## IMB-H110 microATX Motherboard

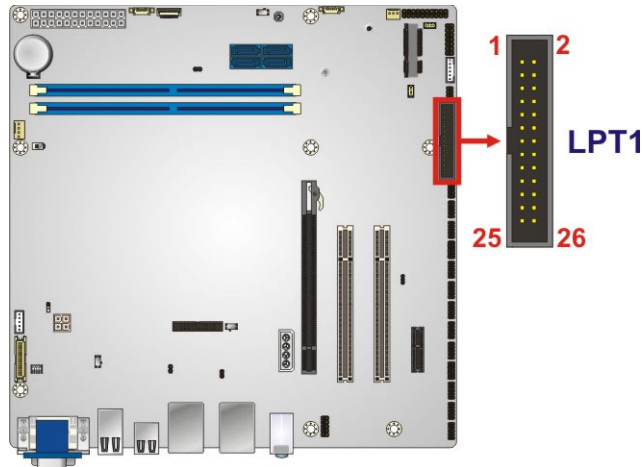

**Figure 3-20: Parallel Port Connector Location**

Pin	Description	Pin	Description
1	STB	2	AFD
3	PPD0	4	ERROR
5	PPD1	6	INIT
7	PPD2	8	SLIN
9	PPD3	10	GND
11	PPD4	12	GND
13	PPD5	14	GND
15	PPD6	16	GND
17	PPD7	18	GND
19	ACK	20	GND
21	BUSY	22	GND,
23	PE	24	GND
25	SLCT	26	NC

**Table 3-19: Parallel Port Connector Pinouts**

### 3.2.20 PCI Slots

**CN Label:** PCI1, PCI2

**CN Type:** PCI Slot

**CN Location:** See **Figure 3-21**

The PCI slot enables a PCI expansion module to be connected to the board.

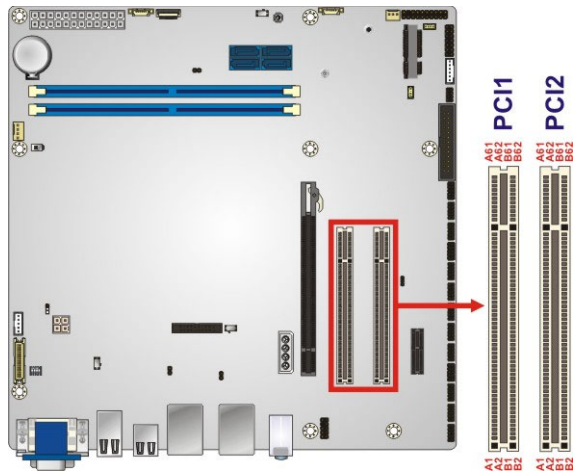
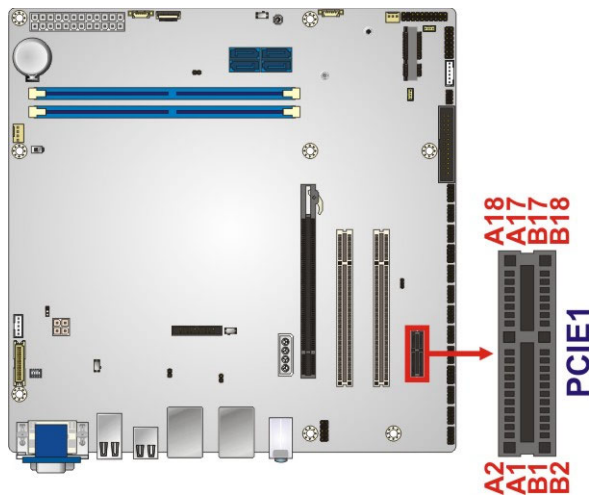

**Figure 3-21: PCI Slot Locations**

### 3.2.21 PCIe x1 Slot

- CN Label:** PCIE1
- CN Type:** PCIe x1 slot
- CN Location:** See **Figure 3-22**

The PCIe x1 expansion card slot is for PCIe x1 expansion card.



**Figure 3-22: PCIe x1 Slot Location**

## IMB-H110 microATX Motherboard

### 3.2.22 PCIe x16 Slot

<b>CN Label:</b>	<b>PCIEX16_1</b>
<b>CN Type:</b>	PCIe x8 slot
<b>CN Location:</b>	See <b>Figure 3-23</b>

The PCIe x16 expansion card slot is for PCIe x16 expansion card.

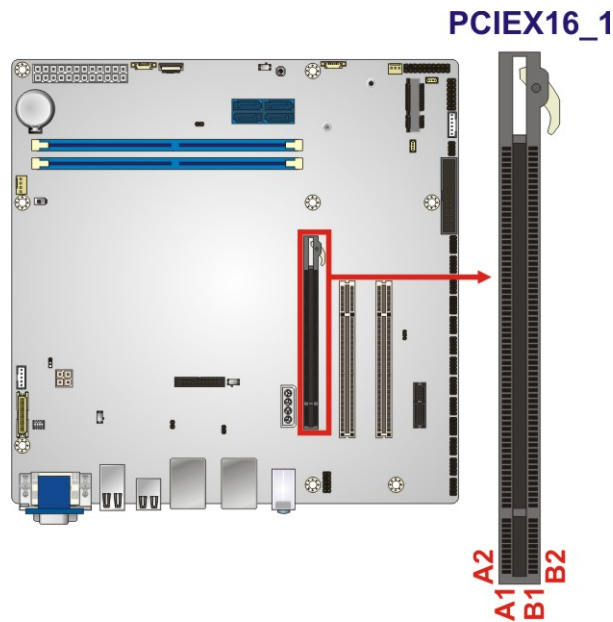
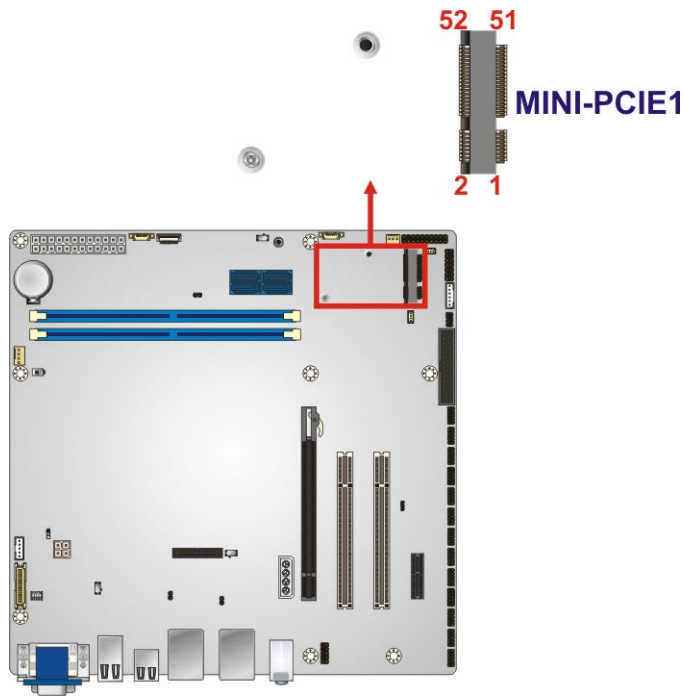

**Figure 3-23: PCIe x16 Slot Location**

### 3.2.23 PCIe Mini Slot

<b>CN Label:</b>	<b>MINI-PCIE1</b>
<b>CN Type:</b>	PCIe Mini slot
<b>CN Location:</b>	See <b>Figure 3-24</b>
<b>CN Pinouts:</b>	See <b>Table 3-20</b>

The PCIe Mini slot is for installing a full-size/half-size PCIe Mini expansion card, such as a wireless LAN card.



**Figure 3-24: PCIe Mini Slot Location**

Pin	Description	Pin	Description
1	NC	2	VCC3V
3	NC	4	GND
5	NC	6	VCC1.5V
7	CLKREQ	8	NC
9	GND	10	NC
11	CLKN	12	NC
13	CLKP	14	NC
15	GND	16	NC
17	NC	18	GND
19	NC	20	VCC3V
21	GND	22	RESET
23	PCIE_RXN	24	SB3V
25	PCIE_RXP	26	GND
27	GND	28	VCC1.5V
29	GND	30	SMB_CLK
31	PCIE_TXN	32	SMB_DATA
33	PCIE_TXP	34	GND

## IMB-H110 microATX Motherboard

Pin	Description	Pin	Description
35	GND	36	USB_N
37	NC	38	USB_P
39	NC	40	GND
41	NC	42	NC
43	NC	44	NC
45	NC	46	NC
47	NC	48	VCC1.5V
49	NC	50	GND
51	NC	52	VCC3V

**Table 3-20: PCIe Mini Slot Pinouts**

### 3.2.24 Power Button

- CN Label:** PWR\_SW1
- CN Type:** Push button
- CN Location:** See **Figure 3-25**

The on-board power button controls system power.

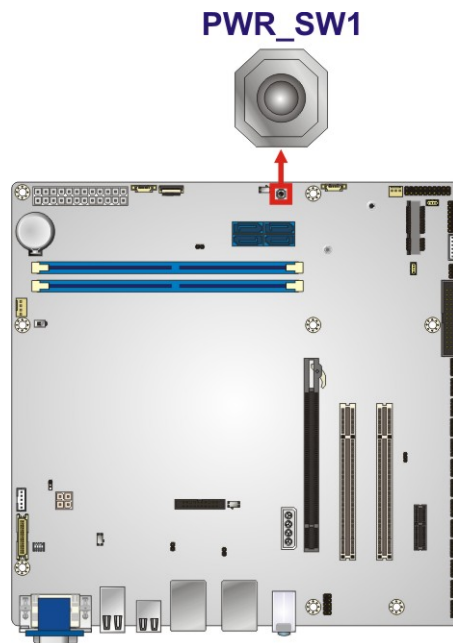

**Figure 3-25: Power Button Location**



**3.2.25 RS-232 Serial Port Connectors**

**CN Label:** COM1, COM2, COM3, COM4, COM7, COM8, COM9, COM10, COM11, COM12

**CN Type:** 10-pin header, p=2.00 mm

**CN Location:** See **Figure 3-27**

**CN Pinouts:** See **Table 3-22**

Each of these connectors provides RS-232 connections.

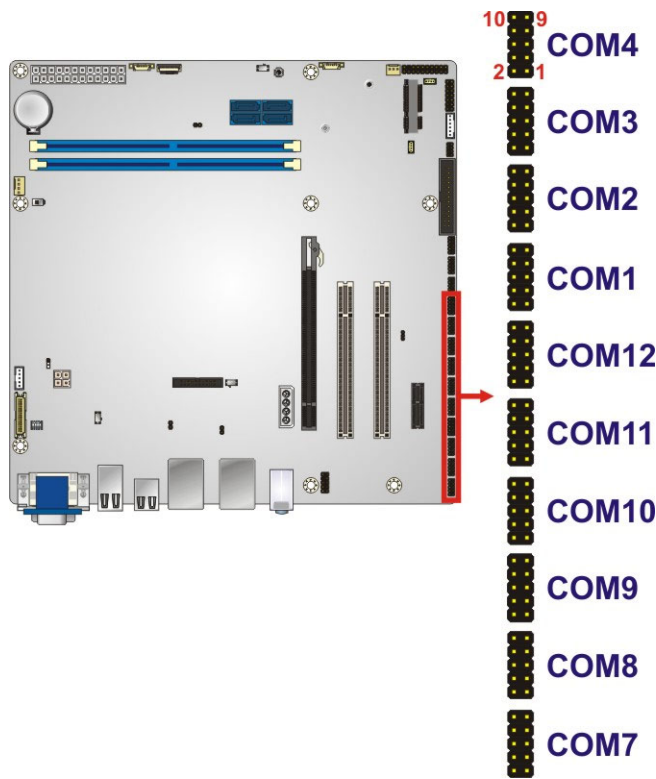

**Figure 3-26: RS-232 Serial Port Connector Locations**

Pin	Description	Pin	Description
1	DCD	2	DSR
3	RX	4	RTS
5	TX	6	CTS
7	DTR	8	RI
9	GND	10	GND

**Table 3-21: RS-232 Serial Port Connector Pinouts**

## IMB-H110 microATX Motherboard

### 3.2.26 RS-232/422/485 Serial Port Connectors

- CN Label:** COM5, COM6
- CN Type:** 10-pin header, p=2.00 mm
- CN Location:** See **Figure 3-27**
- CN Pinouts:** See **Table 3-22**

Each of these connectors provides RS-232/422/485 connections.



**NOTE:**

The communication protocol of the serial ports is set through the BIOS menu in “Advanced → Super IO Configuration → Serial Port 5/6 Configuration”. Use the **Transfer Mode** BIOS option to configure the correspondent serial ports (refer to **Sections 5.3.3.4.2** and **5.3.3.4.3** for detailed information).

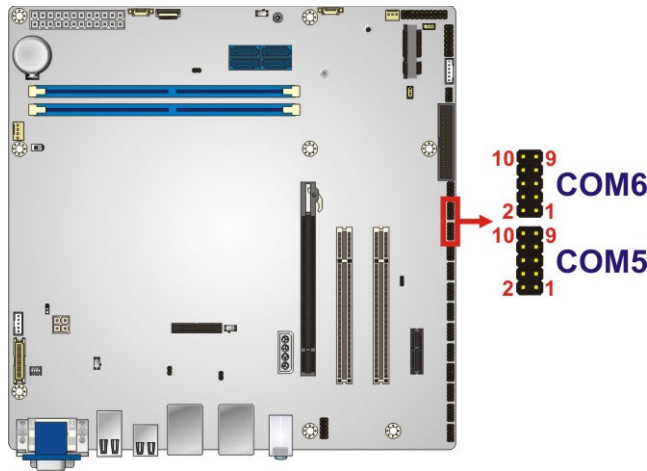

**Figure 3-27: RS-232/422/485 Serial Port Connector Locations**

Pin	Description	Pin	Description
1	DCD/TX-/D-	2	DSR
3	RX/TX+/D+	4	RTS
5	TX/RT+	6	CTS

Pin	Description	Pin	Description
7	DTR/RX-	8	RI
9	GND	10	GND

**Table 3-22: RS-232/422/485 Serial Port Connector Pinouts**

Use the optional RS-232/422/485 cable to connect to a serial device. The pinouts of the DB-9 connector are listed below.

RS-232 Pinouts	RS-422 Pinouts	RS-485 Pinouts

**Table 3-23: DB-9 RS-232/422/485 Pinouts**

### 3.2.27 SATA 6Gb/s Drive Connector

**CN Label:** S\_ATA1, S\_ATA2, S\_ATA3, S\_ATA4

**CN Type:** 7-pin SATA drive connector

**CN Location:** See **Figure 3-28**

**CN Pinouts:** See **Table 3-24**

The SATA drive connectors can be connected to SATA drives and supports up to 6Gb/s data transfer rate.

**IMB-H110 microATX Motherboard**

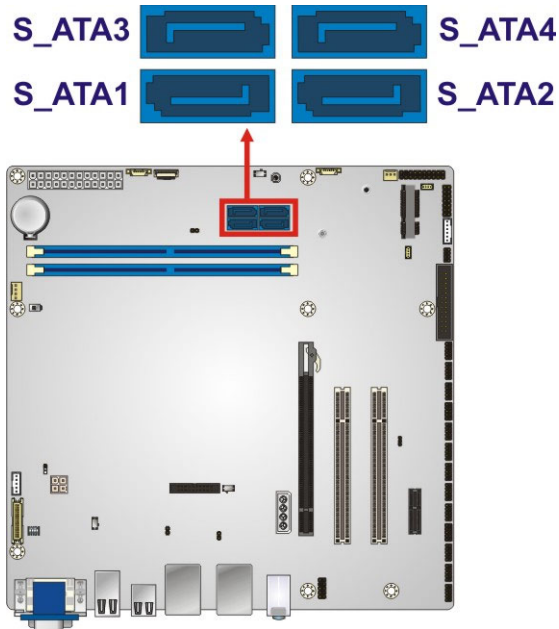

**Figure 3-28: SATA 6Gb/s Drive Connector Locations**

Pin	Description	Pin	Description
1	GND	2	SATA_TXP
3	SATA_TXN	4	GND
5	SATA_RXN	6	SATA_RXP
7	GND		

**Table 3-24: SATA 6Gb/s Drive Connector Pinouts**

**3.2.28 SMBus Connector**

- CN Label:** J\_SMB1
- CN Type:** 4-pin wafer, p=1.25 mm
- CN Location:** See **Figure 3-29**
- CN Pinouts:** See **Table 3-25**

The SMBus (System Management Bus) connector provides low-speed system management communications.

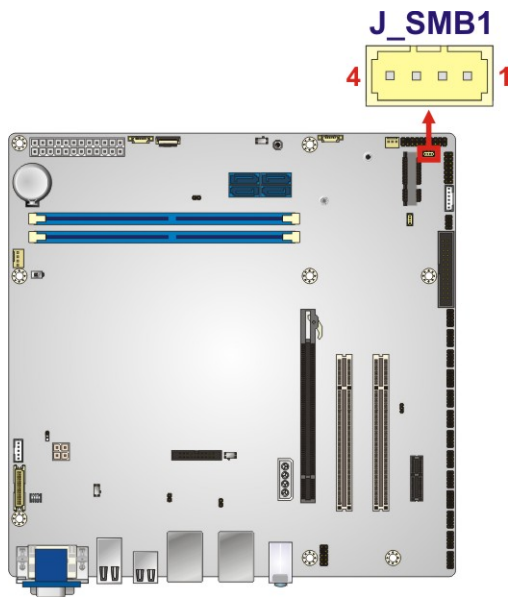

**Figure 3-29: SMBus Connector Location**

Pin	Description
1	GND
2	SMB_DATA
3	SMB_CLK
4	VCC5V

**Table 3-25: SMBus Connector Pinouts**

## IMB-H110 microATX Motherboard

### 3.2.29 SPI Flash Connector

- CN Label:** J\_SPI1
- CN Type:** 6-pin wafer, p=1.25 mm
- CN Location:** See **Figure 3-30**
- CN Pinouts:** See **Table 3-26**

The SPI flash connector is used to flash the SPI ROM.

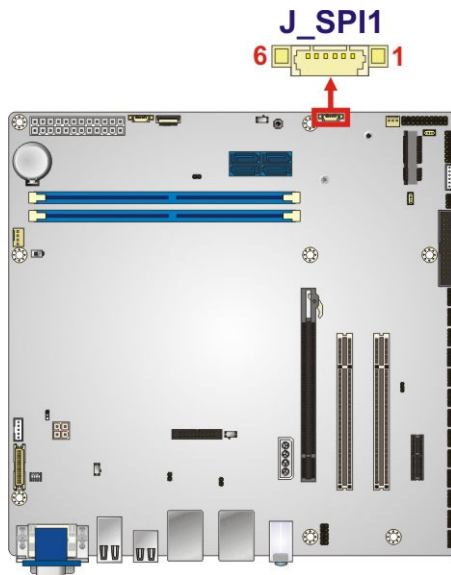

**Figure 3-30: SPI Flash Connector Location**

Pin	Description
1	VCC3V
2	CS
3	MISO
4	CLK
5	MOSI
6	GND

**Table 3-26: SPI Flash Connector Pinouts**

**3.2.30 SPI Flash Connector, EC**

- CN Label:** J\_EC1
- CN Type:** 6-pin wafer, p=1.25 mm
- CN Location:** See **Figure 3-31**
- CN Pinouts:** See **Table 3-27**

The SPI flash connector is used to flash the EC ROM.

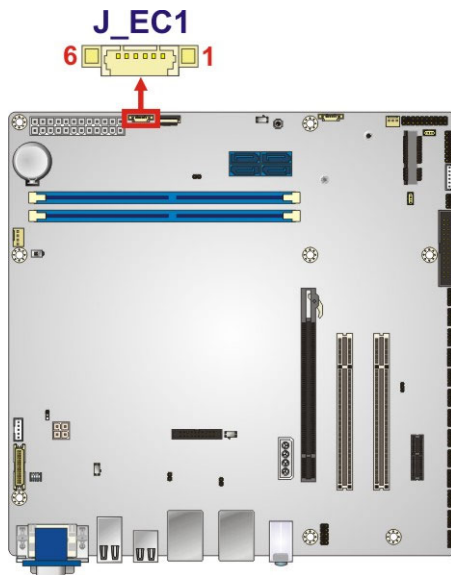

**Figure 3-31: SPI EC Flash Connector Location**

Pin	Description
1	VCC3V
2	CS
3	MISO
4	CLK
5	MOSI
6	GND

**Table 3-27: SPI EC Flash Connector Pinouts**

## IMB-H110 microATX Motherboard

### 3.2.31 TPM Connector

- CN Label:** TPM1
- CN Type:** 20-pin header, p=2.54 mm
- CN Location:** See **Figure 3-32**
- CN Pinouts:** See **Table 3-28**

The TPM connector connects to a TPM module.

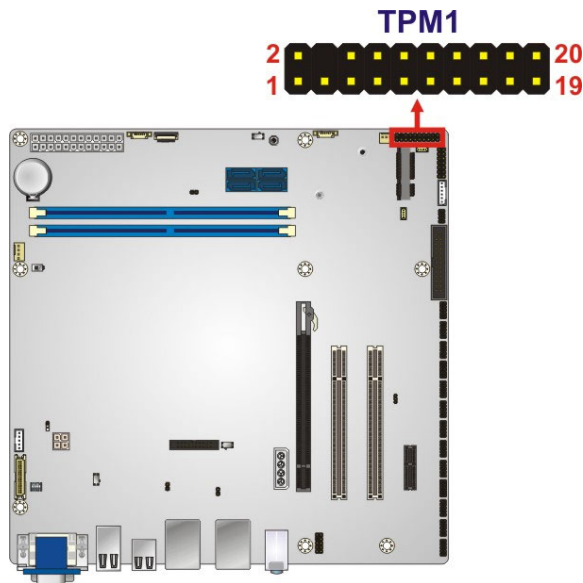

**Figure 3-32: TPM Connector Location**

Pin	Description	Pin	Description
1	CLOCK	2	GND
3	FRAME	4	NC
5	RESET	6	VCC5V
7	LAD3	8	LAD2
9	VCC3V	10	LAD1
11	LAD0	12	GND
13	SMB_CLK	14	SMB_DATA
15	SB3V	16	SERIRO
17	GND	18	CLKRUN
19	LPCPD	20	DRQ

**Table 3-28: TPM Connector Pinouts**



**3.2.32 USB 2.0 Connector**

- CN Label:** J\_USB1
- CN Type:** 8-pin header, p=2.00 mm
- CN Location:** See **Figure 3-33**
- CN Pinouts:** See **Table 3-29**

The USB 2.0 connectors connect to USB 2.0/1.1 devices. Each pin header provides two USB 2.0 ports.

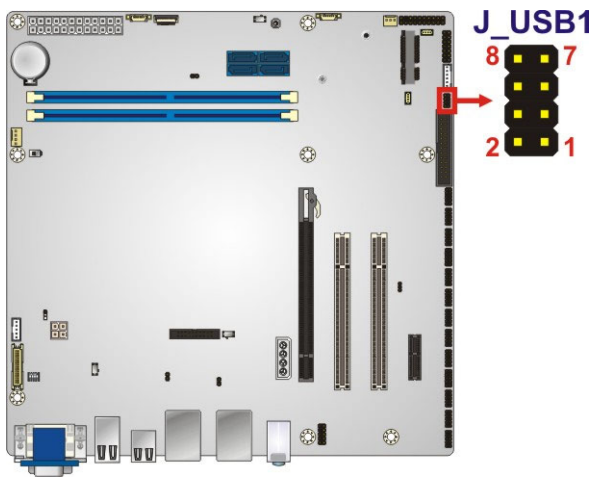

**Figure 3-33: USB 2.0 Connector Locations**

Pin	Description	Pin	Description
1	SB5V	2	GND
3	DATA-	4	DATA+
5	DATA+	6	DATA-
7	GND	8	SB5V

**Table 3-29: USB 2.0 Connector Pinouts**

## IMB-H110 microATX Motherboard

### 3.3 External Peripheral Interface Connector Panel

The figure below shows the external peripheral interface connector (EPIC) panel. The EPIC panel consists of the following:

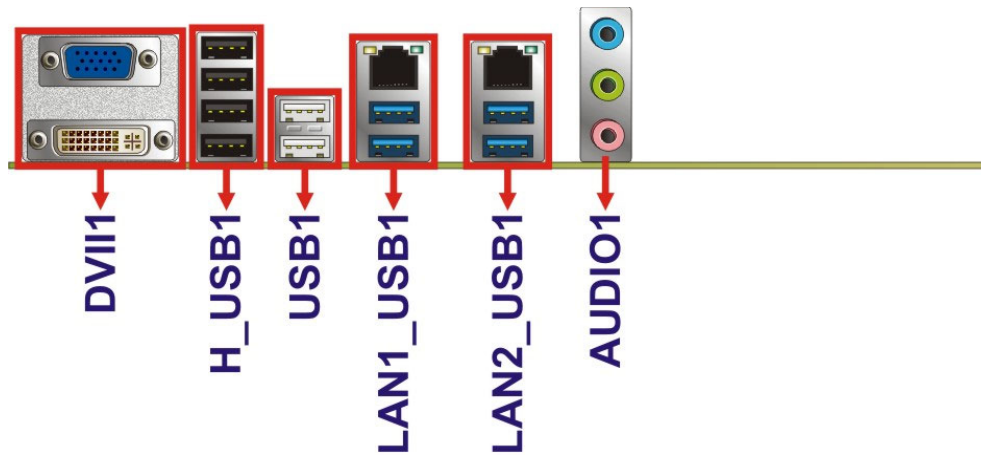

Figure 3-34: External Peripheral Interface Connector

#### 3.3.1 Audio Connector

<b>CN Label:</b>	<b>AUDIO1</b>
<b>CN Type:</b>	Audio jack
<b>CN Location:</b>	See <b>Figure 3-34</b>

The audio jacks connect to external audio devices.

- **Line In port (Light Blue)**: Connects a CD-ROM, DVD player, or other audio devices.
- **Line Out port (Lime)**: Connects to a headphone or a speaker. With multi-channel configurations, this port can also connect to front speakers.
- **Microphone (Pink)**: Connects a microphone.

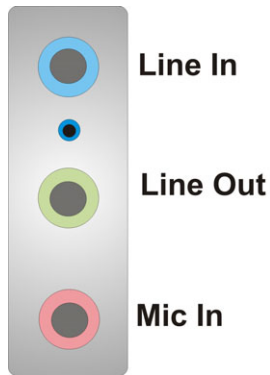

**Figure 3-35: Audio Connector**

### 3.3.2 Ethernet and USB 3.0 Connectors

**CN Label:** LAN1\_USB1, LAN2\_USB1

**CN Type:** RJ-45, USB 3.0

**CN Location:** See **Figure 3-34**

**CN Pinouts:** See **Table 3-30** and **Table 3-31**

There are four external USB 3.0 connectors on the IMB-H110.

Pin	Description	Pin	Description
1	VCC	10	VCC
2	USB_DATA-	11	USB_DATA-
3	USB_DATA+	12	USB_DATA+
4	GND	13	GND
5	USB3_RX-	14	USB3_RX-
6	USB3_RX+	15	USB3_RX+
7	GND	16	GND
8	USB3_TX-	17	USB3_TX-
9	USB3_TX+	18	USB3_TX+

**Table 3-30: USB 3.0 Port Pinouts**

## IMB-H110 microATX Motherboard

Each LAN connector connects to a local network.

Pin	Description	Pin	Description
1	LAN_MDI0P	5	LAN_MDI2P
2	LAN_MDI0N	6	LAN_MDI2N
3	LAN_MDI1P	7	LAN_MDI3P
4	LAN_MDI1N	8	LAN_MDI3N

**Table 3-31: LAN Pinouts**

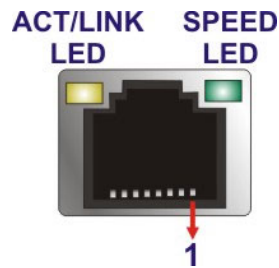

**Figure 3-36: LAN Connector**

### 3.3.3 USB 2.0 Connectors

**CN Label:** USB1, H\_USB1

**CN Type:** USB 2.0

**CN Location:** See **Figure 3-34**

**CN Pinouts:** See **Table 3-32**

The USB 2.0 connector can be connected to a USB 2.0/1.1 device.

Pin	Description
1	SB5V
2	DATA-
3	DATA+
4	GND

**Table 3-32: USB 2.0 Port Pinouts**

### 3.3.4 VGA and DVI-I Connectors

- CN Label:** DVI1
- CN Type:** 15-pin VGA, 24-pin DVI-I
- CN Location:** See **Figure 3-34**
- CN Pinouts:** See **Table 3-33** and **Table 3-34**

The 24-pin Digital Visual Interface (DVI) connector connects to a high-speed, high-resolution digital display. The DVI-I connector supports both digital and analog signals.



**NOTE:**

To connect a CRT monitor to the DVI-I connector, the user has to set the DVI/CRT selection switch to CRT position. Please refer to **Section 4.8.3** for detailed information.

Pin	Description	Pin	Description
1	DATA2-	2	DATA2+
3	GND	4	NC
5	NC	6	DDC CLK
7	DDC DATA	8	VSYNC
9	DATA1-	10	DATA1+
11	GND	12	NC
13	NC	14	VCC5V
15	GND	16	HPDET
17	DATA0-	18	DATA0+
19	GND	20	NC
21	NC	22	GND
23	CLK+	24	CLK-
C1	RED	C2	GREEN
C3	BLUE	C4	HSYNC
C5	GND		

**Table 3-33: DVI-I Connector Pinouts**

## IMB-H110 microATX Motherboard

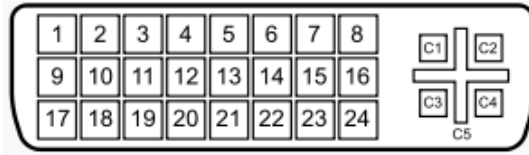

**Figure 3-37: DVI-I Connector**

The 15-pin VGA connector connects to a monitor that accepts a standard VGA input.



**NOTE:**

The user has to connect the VGA connector to the monitor before system booting as the VGA output function is supported via the eDP to VGA converter.

Pin	Description	Pin	Description
1	RED	2	GREEN
3	BLUE	4	NC
5	GND	6	GND
7	GND	8	GND
9	VCC5V	10	GND
11	NC	12	DDCDATA
13	HSYNC	14	VSYNC
15	DDCCLK		

**Table 3-34: VGA Connector Pinouts**

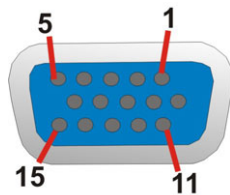

**Figure 3-38: VGA Connector**

Chapter

4

# Installation

---

## IMB-H110 microATX Motherboard

### 4.1 Anti-static Precautions

---



#### WARNING:

Failure to take ESD precautions during the installation of the IMB-H110 may result in permanent damage to the IMB-H110 and severe injury to the user.

---

Electrostatic discharge (ESD) can cause serious damage to electronic components, including the IMB-H110. Dry climates are especially susceptible to ESD. It is therefore critical that whenever the IMB-H110 or any other electrical component is handled, the following anti-static precautions are strictly adhered to.

- **Wear an anti-static wristband:** - Wearing a simple anti-static wristband can help to prevent ESD from damaging the board.
- **Self-grounding:** - Before handling the board touch any grounded conducting material. During the time the board is handled, frequently touch any conducting materials that are connected to the ground.
- **Use an anti-static pad:** When configuring the IMB-H110, place it on an anti-static pad. This reduces the possibility of ESD damaging the IMB-H110.
- **Only handle the edges of the PCB:-:** When handling the PCB, hold the PCB by the edges.

### 4.2 Installation Considerations

---



#### NOTE:

The following installation notices and installation considerations should be read and understood before installation. All installation notices must be strictly adhered to. Failing to adhere to these precautions may lead to severe damage and injury to the person performing the installation.

---



**WARNING:**

The installation instructions described in this manual should be carefully followed in order to prevent damage to the components and injury to the user.

Before and during the installation please **DO** the following:

- Read the user manual:
  - The user manual provides a complete description of the IMB-H110 installation instructions and configuration options.
- Wear an electrostatic discharge cuff (ESD):
  - Electronic components are easily damaged by ESD. Wearing an ESD cuff removes ESD from the body and helps prevent ESD damage.
- Place the IMB-H110 on an anti-static pad:
  - When installing or configuring the motherboard, place it on an anti-static pad. This helps to prevent potential ESD damage.
- Turn all power to the IMB-H110 off:
  - When working with the IMB-H110, make sure that it is disconnected from all power supplies and that no electricity is being fed into the system.

Before and during the installation of the IMB-H110, **DO NOT:**

- Remove any of the stickers on the PCB board. These stickers are required for warranty validation.
- Use the product before verifying all the cables and power connectors are properly connected.
- Allow screws to come in contact with the PCB circuit, connector pins, or its components.

## IMB-H110 microATX Motherboard

### 4.3 Socket LGA1151 CPU Installation



#### WARNING:

CPUs are expensive and sensitive components. When installing the CPU please be careful not to damage it in anyway. Make sure the CPU is installed properly and ensure the correct cooling kit is properly installed.

DO NOT touch the pins at the bottom of the CPU. When handling the CPU, only hold it on the sides.

To install the CPU, follow the steps below.

**Step 1:** Disengage the load lever by pressing the lever down and slightly outward to clear the retention tab. Fully open the lever. See **Figure 4-1**.

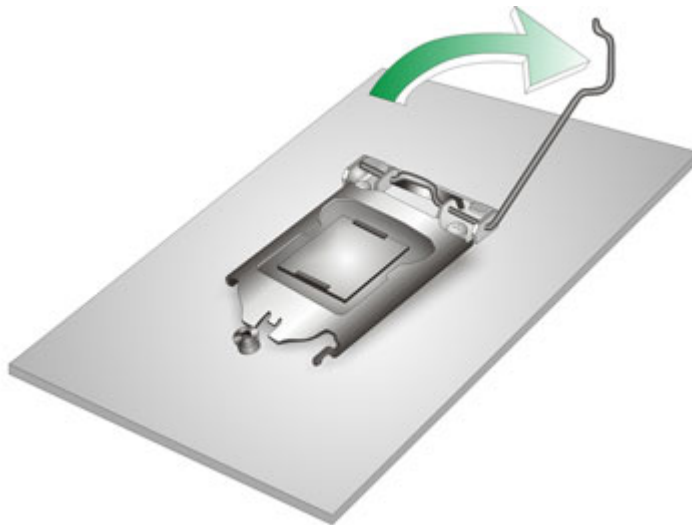

**Figure 4-1: Disengage the CPU Socket Load Lever**

**Step 2:** Open the socket and remove the protective cover. The black protective cover can be removed by pulling up on the tab labeled "Remove". See **Figure 4-2**.

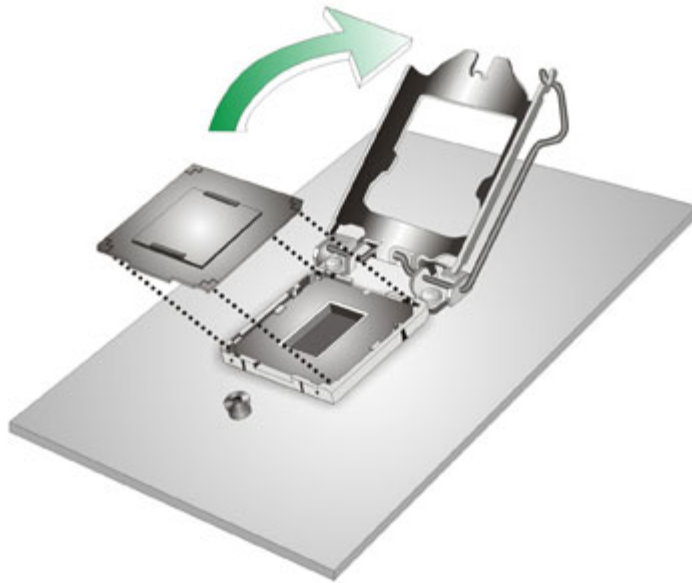

**Figure 4-2: Remove Protective Cover**

- Step 3: Inspect the CPU socket.** Make sure there are no bent pins and make sure the socket contacts are free of foreign material. If any debris is found, remove it with compressed air.
- Step 4: Orientate the CPU properly.** The contact array should be facing the CPU socket.



**WARNING:**

DO NOT touch the pins at the bottom of the CPU. When handling the CPU, only hold it on the sides.

- 
- Step 5: Correctly position the CPU.** Match the Pin 1 mark with the cut edge on the CPU socket.
- Step 6: Align the CPU pins.** Locate pin 1 and the two orientation notches on the CPU. Carefully match the two orientation notches on the CPU with the socket alignment keys.

## IMB-H110 microATX Motherboard

**Step 7: Insert the CPU.** Gently insert the CPU into the socket. If the CPU pins are properly aligned, the CPU should slide into the CPU socket smoothly. See **Figure 4-3**.

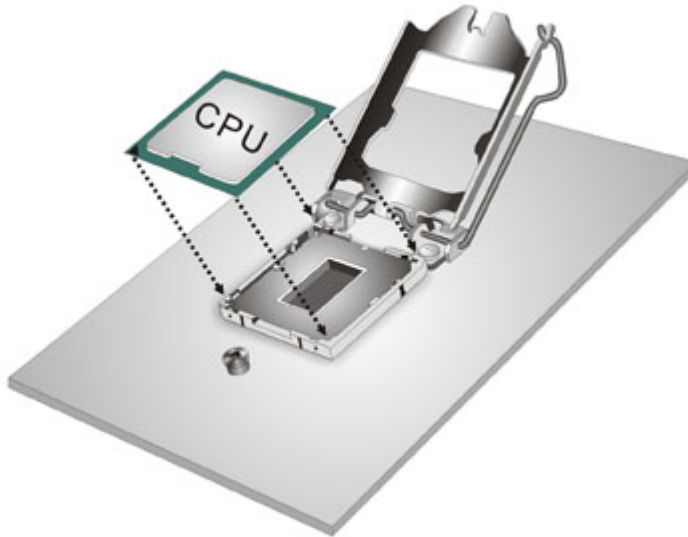

**Figure 4-3: Insert the Socket LGA1151 CPU**

**Step 8: Close the CPU socket.** Close the load plate and pull the load lever back a little to have the load plate be able to secure to the knob. Engage the load lever by pushing it back to its original position (**Figure 4-4**). There will be some resistance, but will not require extreme pressure.

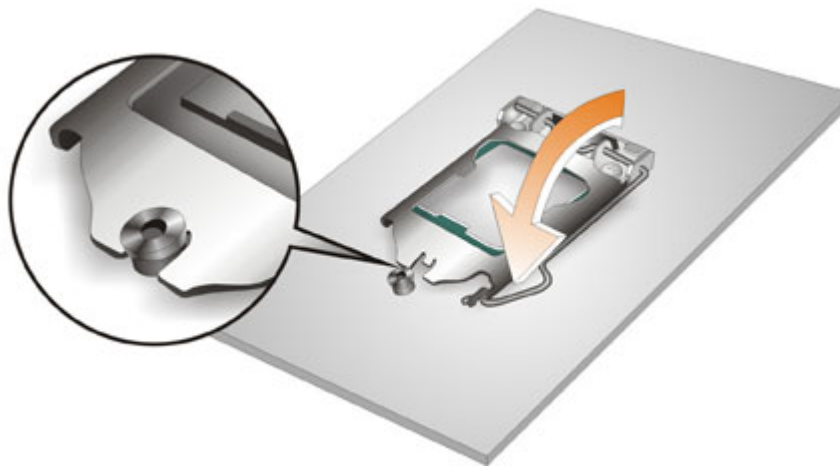

**Figure 4-4: Close the Socket LGA1151**

**Step 9:** Connect the 12 V power to the board. Connect the 12 V power from the power supply to the board.

## 4.4 Socket LGA1151 Cooling Kit Installation

---



### **WARNING:**

**DO NOT** attempt to install a push-pin cooling fan.

The pre-installed support bracket prevents the board from bending and is **ONLY** compatible with captive screw type cooling fans.

---

The cooling kit can be bought from IEI. The cooling kit has a heat sink and fan.

---



### **WARNING:**

Do not wipe off (accidentally or otherwise) the pre-sprayed layer of thermal paste on the bottom of the heat sink. The thermal paste between the CPU and the heat sink is important for optimum heat dissipation.

---

To install the cooling kit, follow the instructions below.

**Step 1:** A cooling kit bracket is pre-installed on the rear of the motherboard. See **Figure 4-5**.

## IMB-H110 microATX Motherboard

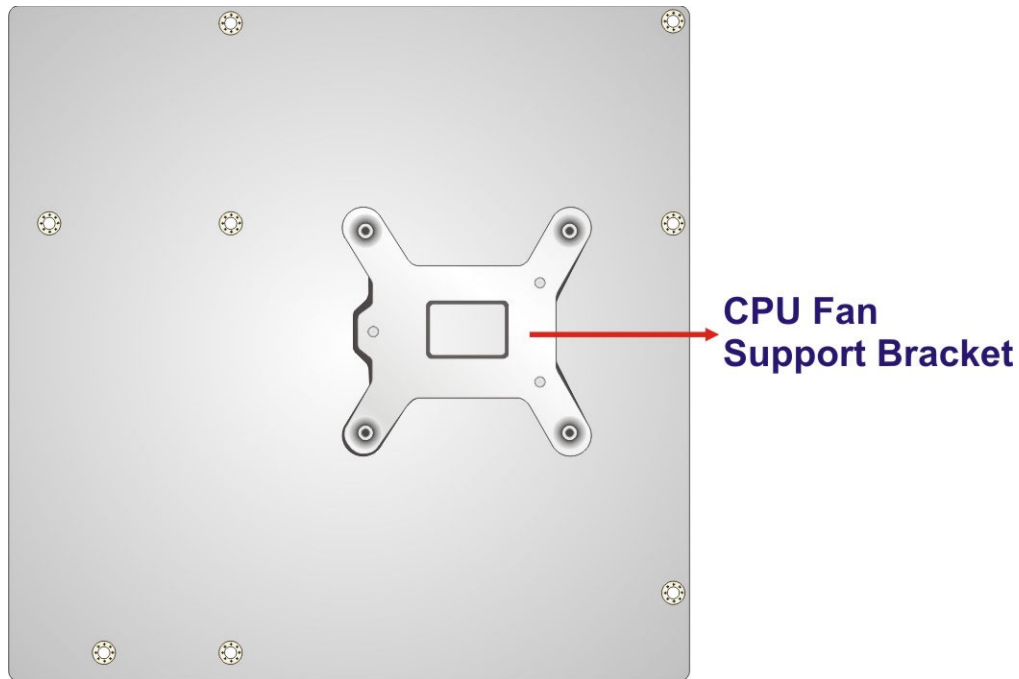
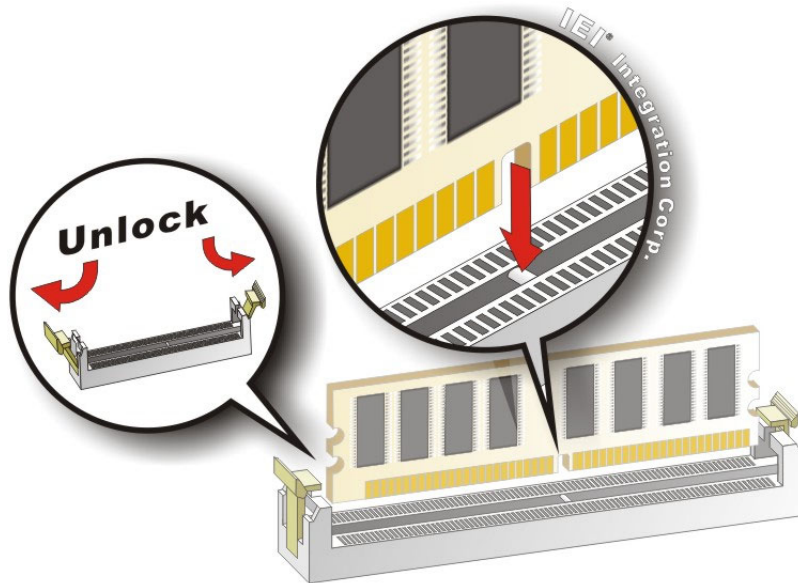

**Figure 4-5: Cooling Kit Support Bracket**

- Step 2:** Place the cooling kit onto the socket LGA1151 CPU. Make sure the CPU cable can be properly routed when the cooling kit is installed.
- Step 3:** Mount the cooling kit. Gently place the cooling kit on top of the CPU. Make sure the four threaded screws on the corners of the cooling kit properly pass through the holes of the cooling kit bracket.
- Step 4:** Tighten the screws. Use a screwdriver to tighten the four screws. In a diagonal pattern, tighten each screw a few turns then move to the next one, until they are all secured. Do not overtighten the screws.
- Step 5:** Connect the fan cable. Connect the cooling kit fan cable to the CPU fan connector on the IMB-H110. Carefully route the cable and avoid heat generating chips and fan blades.

## 4.5 DIMM Installation

To install a DIMM, please follow the steps below and refer to **Figure 4-6**.



**Figure 4-6: DIMM Installation**

- Step 1:** **Open the DIMM socket handles.** Open the two handles outwards as far as they can. See **Figure 4-6**.
- Step 2:** **Align the DIMM with the socket.** Align the DIMM so the notch on the memory lines up with the notch on the memory socket. See **Figure 4-6**.
- Step 3:** **Insert the DIMM.** Once aligned, press down until the DIMM is properly seated. Clip the two handles into place. See **Figure 4-6**.
- Step 4:** To remove a DIMM, push both handles outward. The memory module is ejected by a mechanism in the socket.

## IMB-H110 microATX Motherboard

### 4.6 Full-size PCIe Mini Card Installation

The PCIe Mini card slot allows installation of either a full-size or half-size PCIe Mini card. To install a full-size PCIe Mini card, please follow the steps below.

**Step 1:** Locate the PCIe Mini card slot. See Chapter 3.

**Step 2:** Remove the retention screw. Remove the retention screw as shown in Figure 4-7.

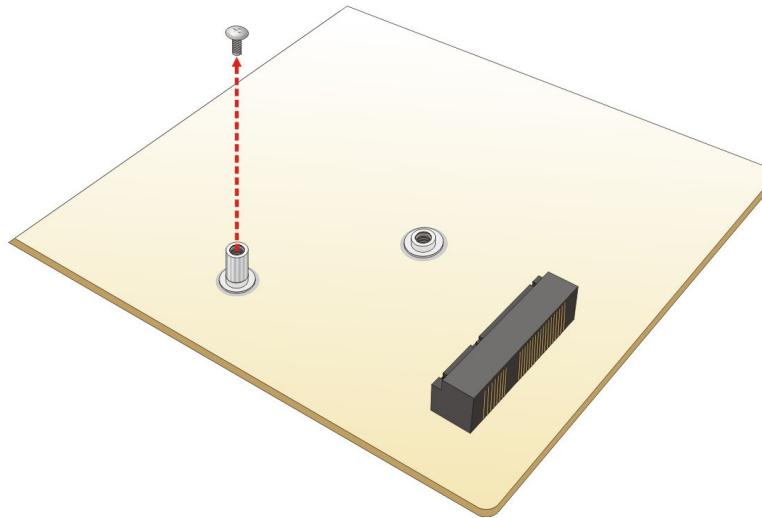

Figure 4-7: Removing the Retention Screw

**Step 3:** Insert into the socket at an angle. Line up the notch on the card with the notch on the slot. Slide the PCIe Mini card into the socket at an angle of about 20° (Figure 4-8).

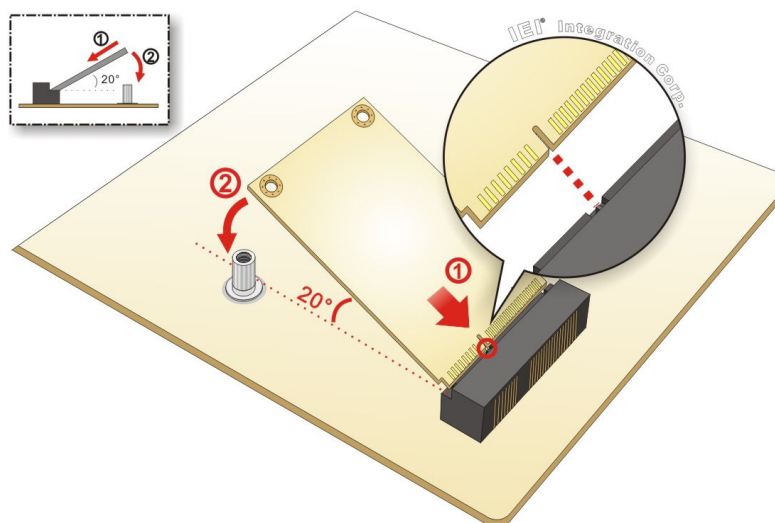
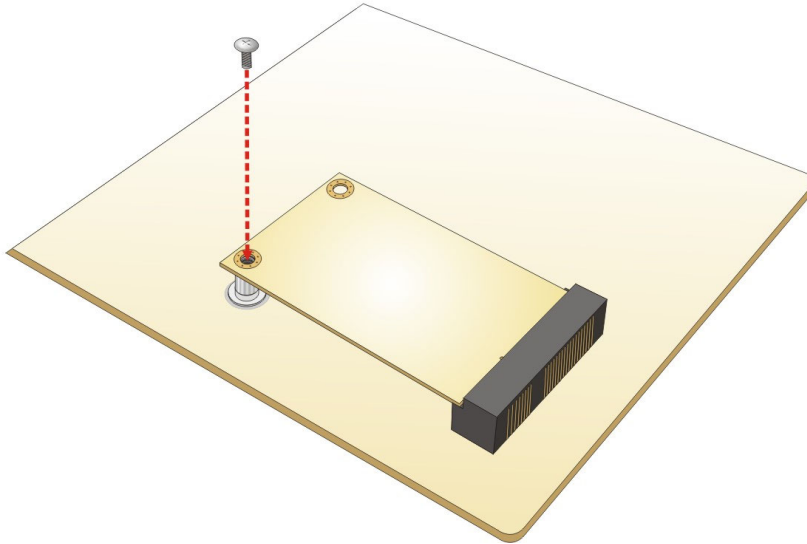

Figure 4-8: Inserting the Full-size PCIe Mini Card into the Slot at an Angle



**Step 4:** **Secure the full-size PCIe Mini card.** Secure the full-size PCIe Mini card with the retention screw previously removed (**Figure 4-9**).



**Figure 4-9: Securing the Full-size PCIe Mini Card**

## 4.7 Half-size PCIe Mini Card Installation

The PCIe Mini card slot allows installation of either a full-size or half-size PCIe Mini card. To install a half-size PCIe Mini card, please follow the steps below.

**Step 1:** **Locate the PCIe Mini card slot.** See **Chapter 3**.

**Step 2:** **Remove the retention screw.** Remove the retention screw as shown in **Figure 4-7**.

**Step 3:** **Remove the standoff.** Unscrew and remove the standoff secured on the motherboard as shown in **Figure 4-10**.

## IMB-H110 microATX Motherboard

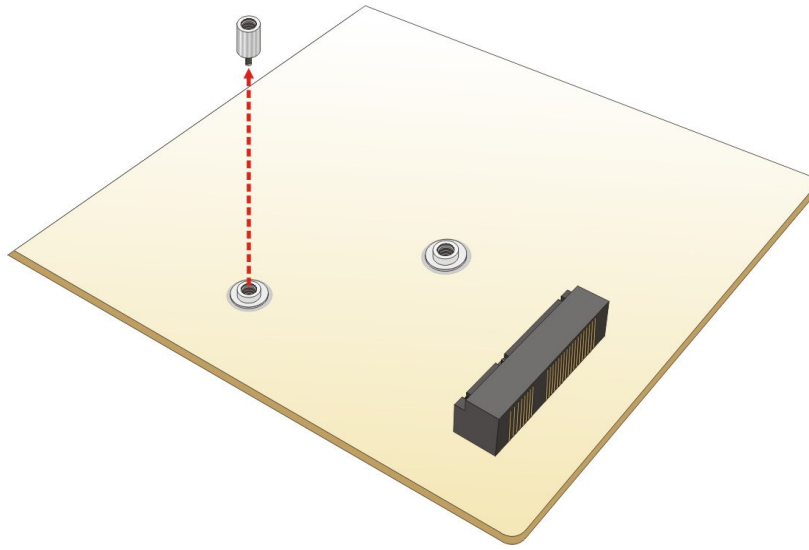

Figure 4-10: Removing the Standoff

**Step 4:** Install the standoff to the screw hole for the half-size PCIe Mini card. Install the previously removed standoff to the screw hole for the half-size PCIe Mini card (Figure 4-11).

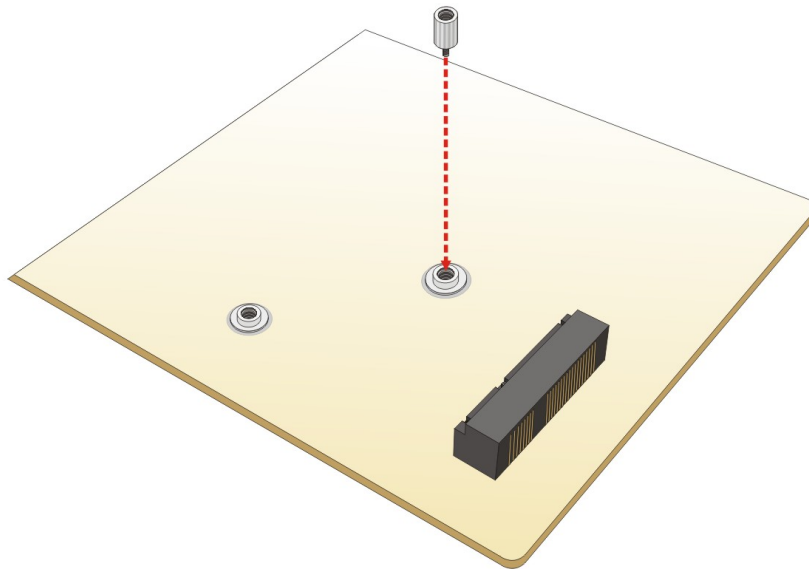
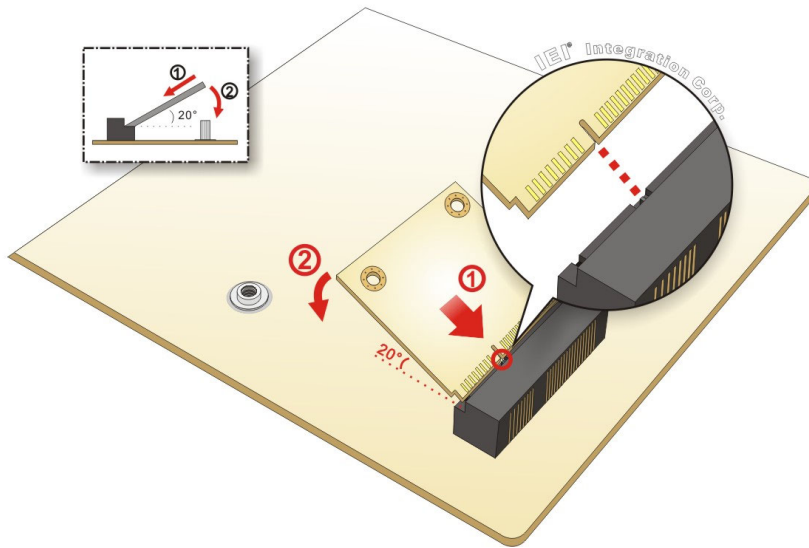

Figure 4-11: Installing the Standoff

**Step 5:** Insert into the socket at an angle. Line up the notch on the card with the notch on the slot. Slide the PCIe Mini card into the slot at an angle of about 20° (Figure 4-12).



**Figure 4-12: Inserting the Half-size PCIe Mini Card into the Slot at an Angle**

**Step 6:** **Secure the half-size PCIe Mini card.** Secure the half-size PCIe Mini card with the retention screw previously removed (**Figure 4-13**).

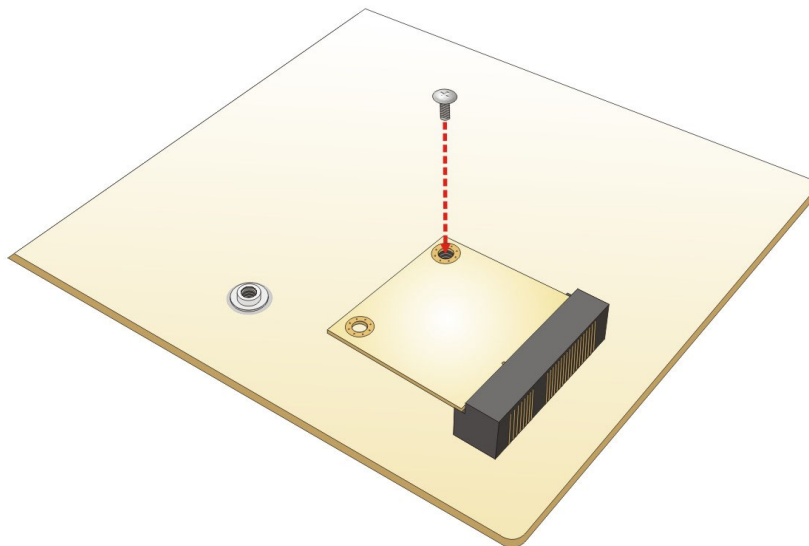

**Figure 4-13: Securing the Half-size PCIe Mini Card**

## IMB-H110 microATX Motherboard

### 4.8 System Configuration

The system configuration should be performed before installation.

#### 4.8.1 AT/ATX Power Mode Setting

The AT and ATX power mode selection is made through the AT/ATX power mode switch which is shown in **Figure 4-14**.

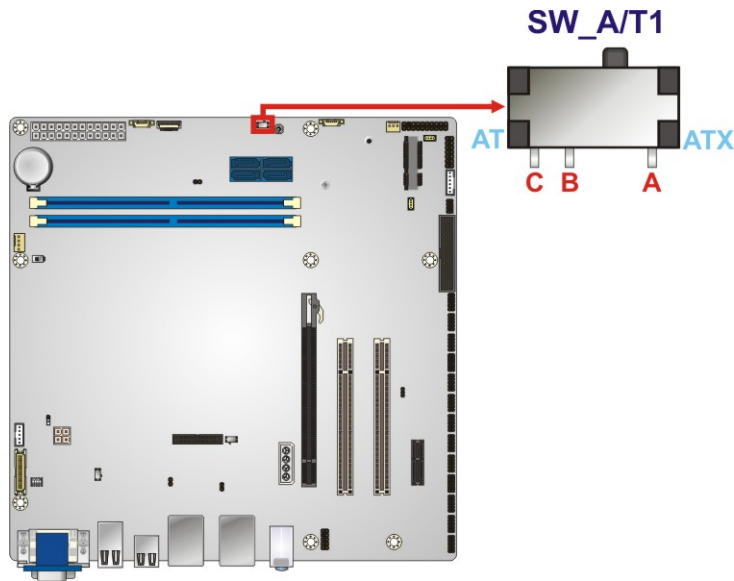

**Figure 4-14: AT/ATX Power Mode Switch Location**

Setting	Description
Short A-B	ATX power mode (default)
Short B-C	AT power mode

**Table 4-1: AT/ATX Power Mode Switch Settings**

#### 4.8.2 Clear CMOS Button

To reset the BIOS, remove the on-board battery and press the clear CMOS button for three seconds or more. The clear CMOS button location is shown in **Figure 4-15**.

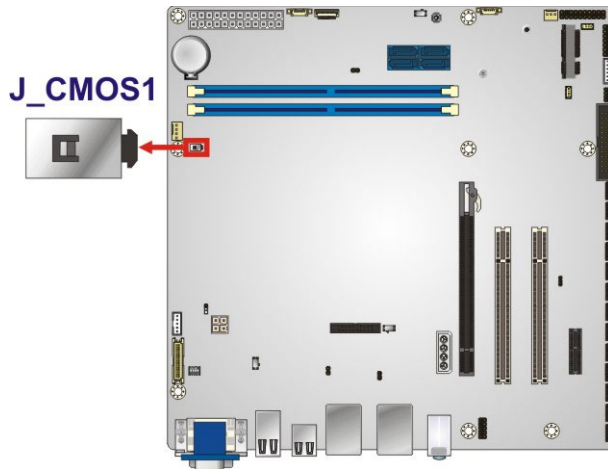

**Figure 4-15: Clear CMOS Button Location**

### 4.8.3 DVI/CRT Selection Switch

The DVI-I connector on the rear panel supports both digital and analog signals. To connect a CRT monitor to the DVI-I connector, the user has to set the DVI/CRT selection switch to CRT position. Refer to **Figure 4-16** and **Table 4-2** for the switch location and settings.

Setting	Description
Short A-B	DVI monitor (Default)
Short B-C	CRT monitor

**Table 4-2: DVI/CRT Selection Switch Settings**

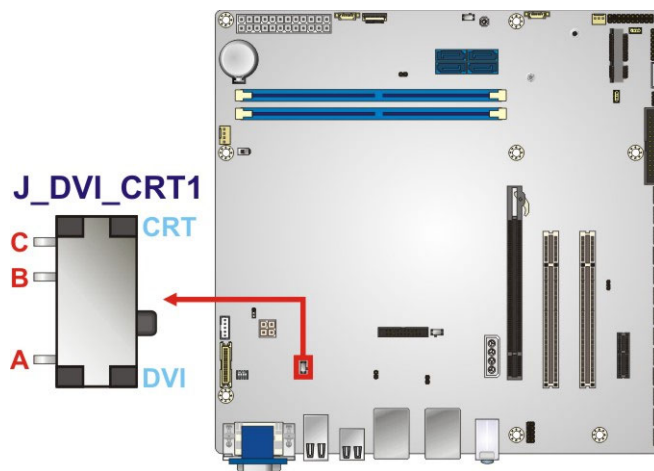

**Figure 4-16: DVI/CRT Selection Switch Location**

## IMB-H110 microATX Motherboard

### 4.8.4 Flash Descriptor Security Override Jumper

The flash descriptor security override jumper (J\_FLASH2) allows to enable or disable the ME firmware update. Refer to **Table 4-3** and **Figure 4-17** for the jumper location and settings.

Setting	Description
Short 1-2	Disabled (default)
Short 2-3	Enabled

**Table 4-3: Flash Descriptor Security Override Jumper Settings**

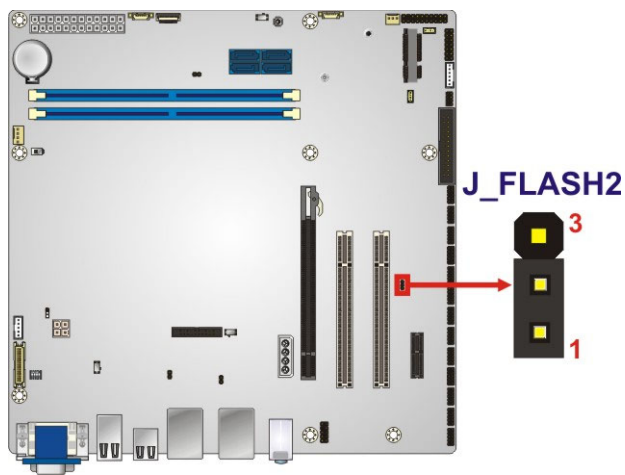

**Figure 4-17: Flash Descriptor Security Override Jumper Location**

To update the ME firmware, please follow the steps below.

- Step 1:** Before turning on the system power, short pin 2-3 of the flash descriptor security override jumper.
- Step 2:** Update the BIOS and ME firmware, and then turn off the system power.
- Step 3:** Remove the metal clip on the flash descriptor security override jumper or return to its default setting (short pin 1-2).
- Step 4:** Restart the system. The system will reboot 2 ~ 3 times to complete the ME firmware update.

### 4.8.5 LVDS Panel Resolution Selection Switch

Use the LVDS panel resolution selection switch to select the resolution of the LCD panel connected to the LVDS connector.

\* ON=0, OFF=1; Single=S, Dual=D

SW1 (4-3-2-1)	Description
0000	800x600 18-bit S (default)
0001	1024x768 18-bit S
0010	1024x768 24-bit S
0011	1280x768 18-bit S
0100	1280x800 18-bit S
0101	1280x960 18-bit S
0110	1280x1024 24-bit D
0111	1366x768 18-bit S
1000	1366x768 24-bit S
1001	1440x960 24-bit D
1010	1400x1050 24-bit D
1011	1600x900 24-bit D
1100	1680x1050 24-bit D
1101	1600x1200 24-bit D
1110	1920x1080 24-bit D
1111	1920x1200 24-bit D

**Table 4-4: LVDS Panel Resolution Selection**

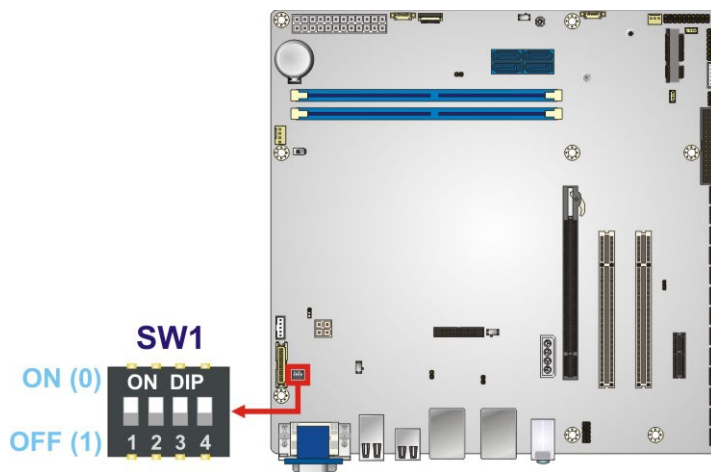

**Figure 4-18: LVDS Panel Resolution Selection Switch Location**

## IMB-H110 microATX Motherboard

### 4.8.6 LVDS Voltage Selection Jumper



**WARNING:**

Permanent damage to the screen and IMB-H110 may occur if the wrong voltage is selected with this jumper. Please refer to the user guide that came with the monitor to select the correct voltage.

The LVDS voltage selection switch allows setting the voltage provided to the monitor connected to the LVDS connector. The LVDS voltage selection switch settings are shown in **Table 4-5**.

Setting	Description
Short 1-2	Keep VCC3V panel setup (Default)
Short 2-3	Keep VCC5V panel setup

**Table 4-5: LVDS Voltage Selection Jumper Settings**

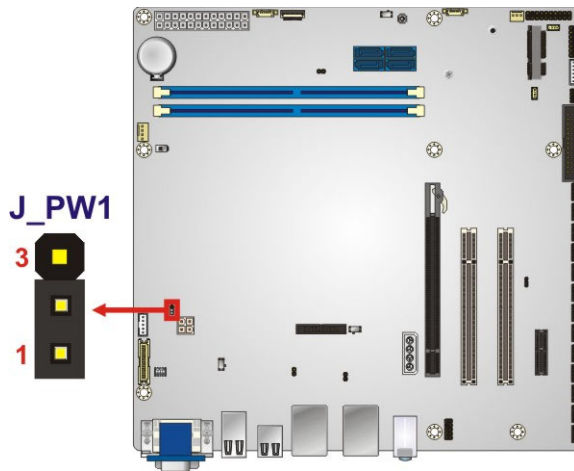

**Figure 4-19: LVDS Voltage Selection Jumper Location**



### 4.8.7 LVDS/iDP Selection Switch

The user can select either to use the LVDS connector or the internal DisplayPort connector. Use the LVDS/iDP selection switch (**Figure 4-20**) to configure the settings (**Table 4-6**).

Setting	Description
Short A-B	LVDS panel (Default)
Short B-C	iDP monitor

**Table 4-6: LVDS/iDP Selection Switch Settings**

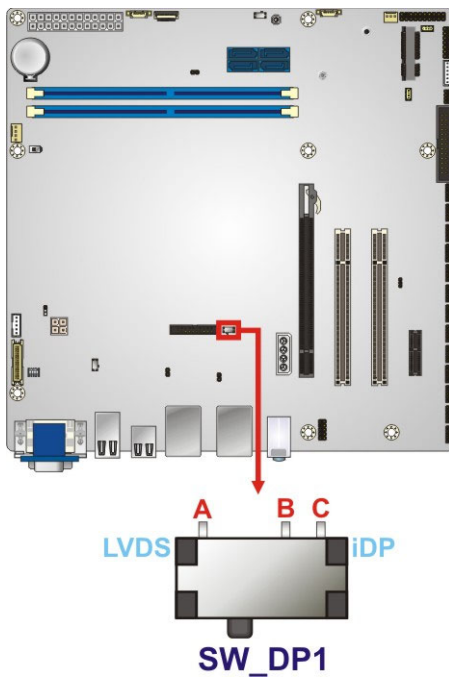

**Figure 4-20: LVDS/iDP Selection Switch Location**

## IMB-H110 microATX Motherboard

### 4.8.8 USB Power Selection

The USB power selection is made through the BIOS menu in “Chipset → PCH-IO Configuration”. Use the **USB Power SW1** and the **USB Power SW2** BIOS options to configure the correspondent USB ports (see **Table 4-7**) and refer to **Table 4-8** to select the USB power source.

BIOS Options	Configured USB Ports
USB Power SW1	LAN1_USB1 (external USB 3.0 ports) LAN2_USB1 (external USB 3.0 ports)
USB Power SW2	USB1 (External USB 2.0 ports) H_USB1 (External USB 2.0 ports) J_USB1 (internal USB 2.0 ports)

**Table 4-7: BIOS Options and Configured USB Ports**

Options	Description
+5V DUAL	+5V dual (default)
+5V	+5V

**Table 4-8: USB Power Source Setup**

Please refer to **Section 5.4.2** for BIOS setup.

## 4.9 Internal Peripheral Device Connections

This section outlines the installation of peripheral devices to the onboard connectors.

### 4.9.1 SATA Drive Connection

The IMB-H110 is shipped with two SATA drive cables. To connect the SATA drives to the connectors, please follow the steps below.

**Step 1: Locate the connectors.** The locations of the SATA drive connectors are shown in **Chapter 3**.

**Step 2: Insert the cable connector.** Insert the cable connector into the on-board SATA drive connector until it clips into place. See **Figure 4-21**.

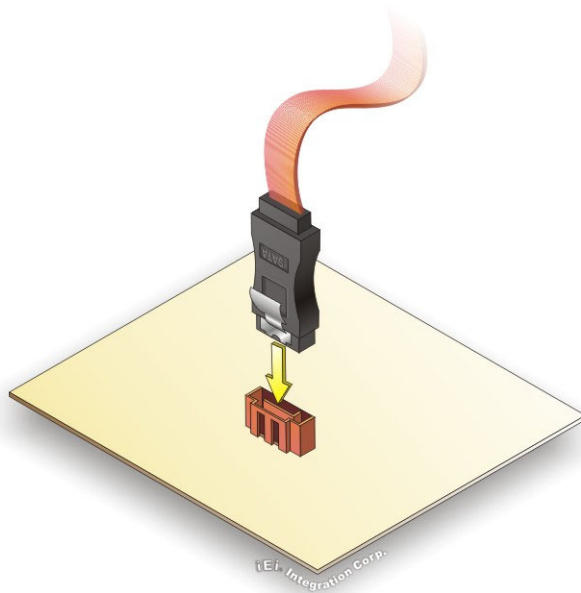

**Figure 4-21: SATA Drive Cable Connection**

- Step 3:** **Connect the cable to the SATA disk.** Connect the connector on the other end of the cable to the connector at the back of the SATA drive. See **Figure 4-22**.
- Step 4:** **Connect the SATA power cable.** Connect the SATA power connector to the back of the SATA drive. See **Figure 4-22**.

## IMB-H110 microATX Motherboard

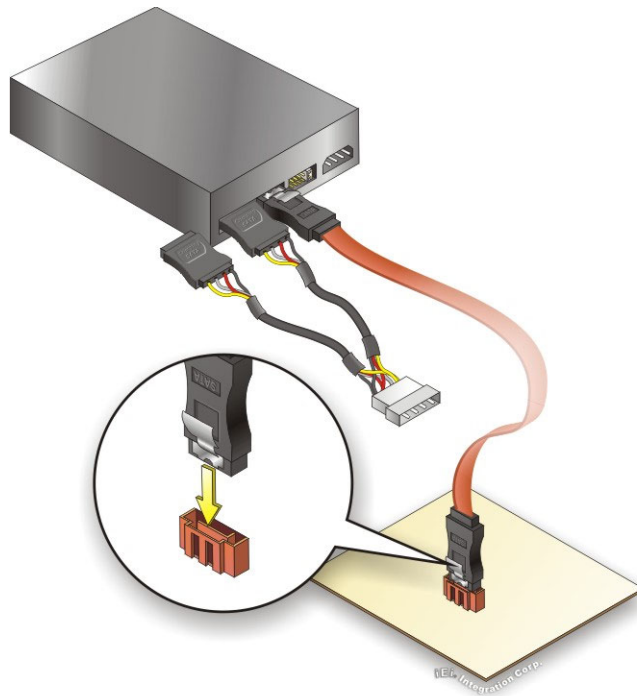

**Figure 4-22: SATA Power Drive Connection**

The SATA power cable can be bought from IEI. See Optional Items in Section 2.4.

### 4.10 Adding USB 3.0 Drivers to a Windows 7 Installation Image

The Windows 7 installation media does not include native driver support for USB 3.0. In order to use the USB keyboard or mouse connected to a USB 3.0 port during OS installation, the user has to update the Windows 7 installation image so that it contains USB 3.0 drivers. Please follow the instructions below to complete the task.

**Step 1:** Prepare a USB flash drive installer.

On a working computer, use your Windows 7 DVD or ISO image to create a bootable USB flash drive.

**Step 2:** Download the Windows 7 USB 3.0 Creator Utility from:

<https://downloadcenter.intel.com/download/25476/Windows-7-USB-3-0-Creator-Utility>.

**Step 3:** Extract the downloaded file to a temporary folder on a computer where the user has logged in as the administrator.



**NOTE:**

The OS version of the computer can be Windows 7, Windows 8.1 or Windows 10.

**Step 4:** Connect the USB drive containing the Windows 7 installation image to the computer.

**Step 5:** Right click on **Installer\_Creator.exe** from the extracted files and select **Run as administrator**.

**Step 6:** The Windows 7 USB 3.0 Creator Utility screen appears (**Figure 4-23**). Click  to browse to the root of the USB drive containing the Windows 7 image.

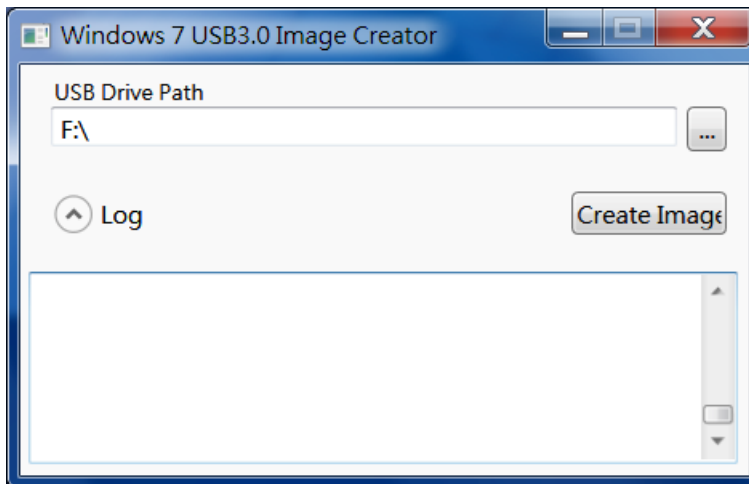
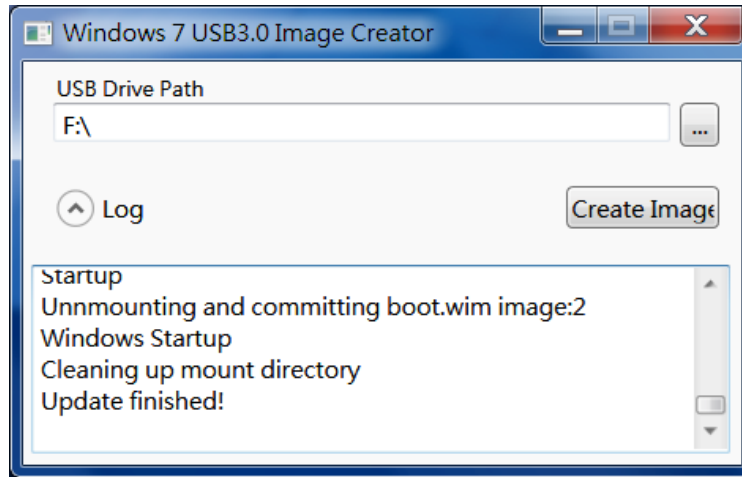

**Figure 4-23: Windows 7 USB 3.0 Creator Utility**

**Step 7:** Click **Create Image** to start the update process.

## IMB-H110 microATX Motherboard

**Step 8:** Wait for the process to finish. It may take up to 15 minutes.



**Figure 4-24: Update Process is Complete**

**Step 9:** Now the user can proceed with the Windows 7 installation using the updated installer.

### 4.11 Driver Installation

All the drivers for the IMB-H110 are on the CD that came with the system. To install the drivers, please follow the steps below.



#### **NOTE:**

The content of the CD may vary throughout the life cycle of the product and is subject to change without prior notice. Visit the IEI website or contact technical support for the latest updates.

---

**Step 1:** Insert the CD into a CD drive connected to the system.



#### **NOTE:**

If the installation program doesn't start automatically:  
Click "Start->My Computer->CD Drive->autorun.exe"

---

**Step 2:** The driver main menu appears. Click IMB-H110.

**Step 3:** A new screen with a list of available drivers appears.

**Step 4:** Install all of the necessary drivers in the menu.

Chapter

**5**

**BIOS**

---



## 5.1 Introduction

The BIOS is programmed onto the BIOS chip. The BIOS setup program allows changes to certain system settings. This chapter outlines the options that can be changed.



### NOTE:

Some of the BIOS options may vary throughout the life cycle of the product and are subject to change without prior notice.

### 5.1.1 Starting Setup

The UEFI BIOS is activated when the computer is turned on. The setup program can be activated in one of two ways.

1. Press the **DEL** or **F2** key as soon as the system is turned on or
2. Press the **DEL** or **F2** key when the “**Press DEL or F2 to enter SETUP**” message appears on the screen.

If the message disappears before the **DEL** or **F2** key is pressed, restart the computer and try again.

### 5.1.2 Using Setup

Use the arrow keys to highlight items, press **ENTER** to select, use the PageUp and PageDown keys to change entries, press **F1** for help and press **ESC** to quit. Navigation keys are shown in the following table.

Key	Function
Up arrow	Move to previous item
Down arrow	Move to next item
Left arrow	Move to the item on the left hand side
Right arrow	Move to the item on the right hand side
+	Increase the numeric value or make changes
-	Decrease the numeric value or make changes
Page Up	Move to the previous page
Page Dn	Move to the next page

## IMB-H110 microATX Motherboard

Key	Function
Esc	Main Menu – Quit and not save changes into CMOS Status Page Setup Menu and Option Page Setup Menu -- Exit current page and return to Main Menu
F1	General help, only for Status Page Setup Menu and Option Page Setup Menu
F2	Load previous values
F3	Load optimized defaults
F4	Save changes and Exit BIOS

**Table 5-1: BIOS Navigation Keys**

### 5.1.3 Getting Help

When **F1** is pressed, a small help window describing the appropriate keys to use and the possible selections for the highlighted item appears. To exit the Help Window, press **Esc**.

### 5.1.4 Unable to Reboot after Configuration Changes

If the computer cannot boot after changes to the system configuration is made, CMOS defaults. Use the clear CMOS button described in **Chapter 4**.

### 5.1.5 BIOS Menu Bar

The **menu bar** on top of the BIOS screen has the following main items:

- Main – Changes the basic system configuration.
- Advanced – Changes the advanced system settings.
- Chipset – Changes the chipset settings.
- Security – Sets User and Supervisor Passwords.
- Boot – Changes the system boot configuration.
- Save & Exit – Selects exit options and loads default settings

The following sections completely describe the configuration options found in the menu items at the top of the BIOS screen and listed above.

## 5.2 Main

The **Main** BIOS menu (**BIOS Menu 1**) appears when the **BIOS Setup** program is entered.

The **Main** menu gives an overview of the basic system information.

Aptio Setup Utility - Copyright (C) 2016 American Megatrends, Inc.					
Main	Advanced	Chipset	Security	Boot	Save & Exit
BIOS Information					Set the Date. Use Tab to switch between Date elements.  ----- →←: Select Screen ↑↓: Select Item Enter: Select +/-: Change Opt. F1: General Help F2: Previous Values F3: Optimized Defaults F4: Save & Exit ESC: Exit
BIOS Vendor		American Megatrends			
Core Version		5.11			
Compliance		UEFI 2.4; PI 1.3			
Project Version		B388AT09.ROM			
Build Date and Time		06/14/2016 14:20:17			
iWDD Vendor		iEi			
iWDD Version		B388ER02.bin			
Processor Information					
Name		SkyLake DT			
Brand String		Intel(R) Core(TM) i3-6100 CPU @ 3.70GHz			
Frequency		3700 MHz			
Processor ID		506E3			
Stepping		R0/S0/N0			
Number of Processors		2Core(s) / 4Thread(s)			
Microcode Revision		7C			
GT Info		GT2			
IGFX VBIOS Version		1036			
Memory RC Version		1.8.0.1			
Total Memory		8192 MB			
Memory Frequency		2133 MHz			
PCH Information					
Name		SKL PCH-H			
PCH SKU		PCH-H Desktop H110 SKU			
Stepping		31/D1			
LAN PHY Revision		N/A			
ME FW Version		11.0.0.1205			
ME Firmware SKU		Consumer SKU			
SPI Clock Frequency					
DOFR Support		Unsupported			
Read Status Clock Frequency		17 MHz			
Write Status Clock Frequency		48 MHz			
Fast Read Status Clock Frequency		48 MHz			
Access Level		Administrator			
System Date		[Thu 07/21/2016]			
System Time		[15:10:27]			
Version 2.17.1255. Copyright (C) 2016 American Megatrends, Inc.					

BIOS Menu 1: Main

## IMB-H110 microATX Motherboard

The **Main** menu has two user configurable fields:

→ **System Date [xx/xx/xx]**

Use the **System Date** option to set the system date. Manually enter the day, month and year.

→ **System Time [xx:xx:xx]**

Use the **System Time** option to set the system time. Manually enter the hours, minutes and seconds.

### 5.3 Advanced

Use the **Advanced** menu (**BIOS Menu 2**) to configure the CPU and peripheral devices through the following sub-menus:



#### WARNING!

Setting the wrong values in the sections below may cause the system to malfunction. Make sure that the settings made are compatible with the hardware.

```

Aptio Setup Utility - Copyright (C) 2016 American Megatrends, Inc.
Main  Advanced  Chipset  Security  Boot  Save & Exit  Server Mgmt
-----
> Trusted Computing
> ACPI Settings
> Super IO Configuration
> F81866SEC Super IO Configuration
> iWDD H/M Monitor
> RTC Wake Settings
> Serial Port Console Redirection
> CPU Configuration
> SATA Configuration
> NVMe Configuration
> USB Configuration
> iEi Feature

Configure Active
Management Technology
Parameters
-----
→←: Select Screen
↑ ↓: Select Item
Enter: Select
+/-: Change Opt.
F1: General Help
F2: Previous Values
F3: Optimized Defaults
F4: Save & Exit
ESC: Exit

Version 2.17.1255. Copyright (C) 2016 American Megatrends, Inc.
    
```

**BIOS Menu 2: Advanced**

### 5.3.1 Trusted Computing

Use the **Trusted Computing** menu (**BIOS Menu 3**) to configure settings related to the Trusted Computing Group (TCG) Trusted Platform Module (TPM).

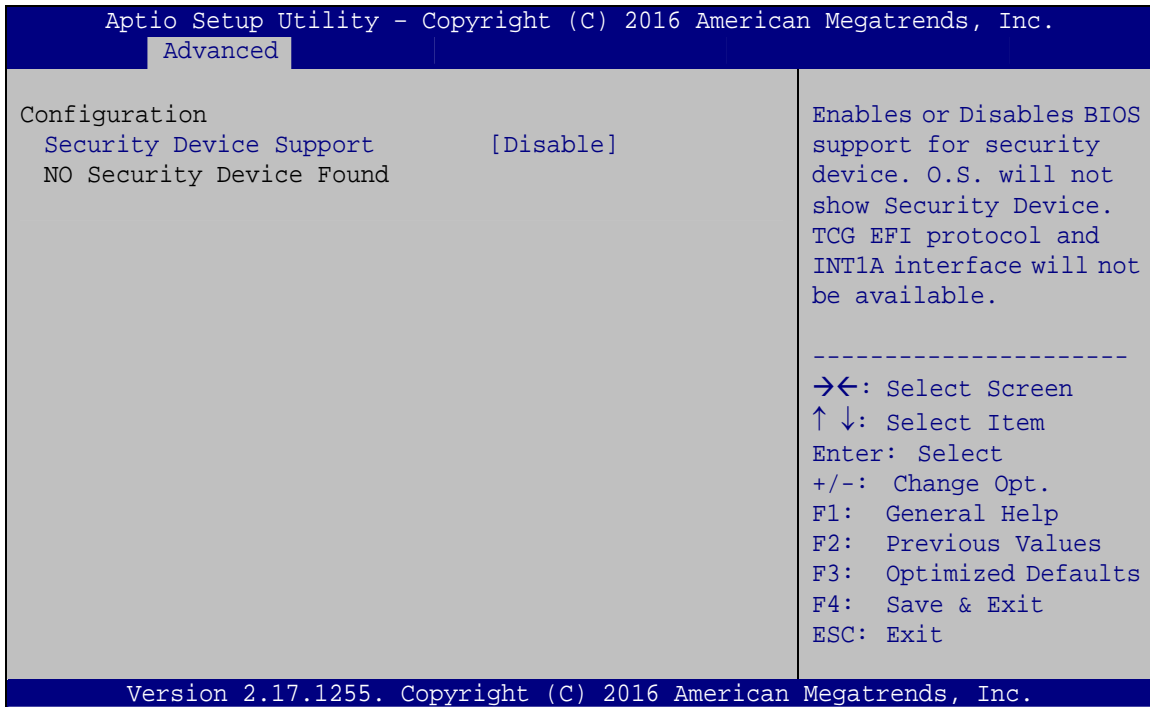

#### BIOS Menu 3: Trusted Computing

##### → Security Device Support [Disable]

Use the **Security Device Support** option to configure support for the TPM.

- **Disable**    DEFAULT    TPM support is disabled.
- **Enable**                    TPM support is enabled.

## IMB-H110 microATX Motherboard

### 5.3.2 ACPI Settings

The **ACPI Settings** menu (**BIOS Menu 4**) configures the Advanced Configuration and Power Interface (ACPI) options.

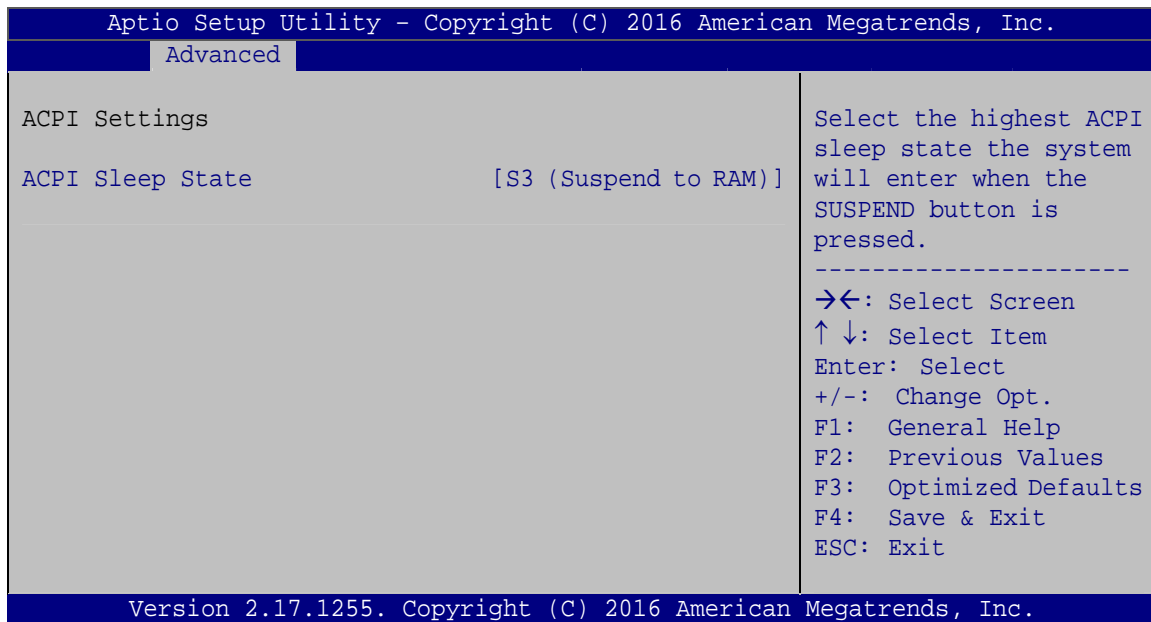

#### BIOS Menu 4: ACPI Configuration

##### → ACPI Sleep State [S3 (Suspend to RAM)]

Use the **ACPI Sleep State** option to specify the sleep state the system enters when it is not being used.

- **S3 (Suspend to RAM)**      **DEFAULT**      The caches are flushed and the CPU is powered off. Power to the RAM is maintained. The computer returns slower to a working state, but more power is saved.

### 5.3.3 Super IO Configuration

Use the **Super IO Configuration** menu (**BIOS Menu 5**) to set or change the configurations for the parallel ports and serial ports.

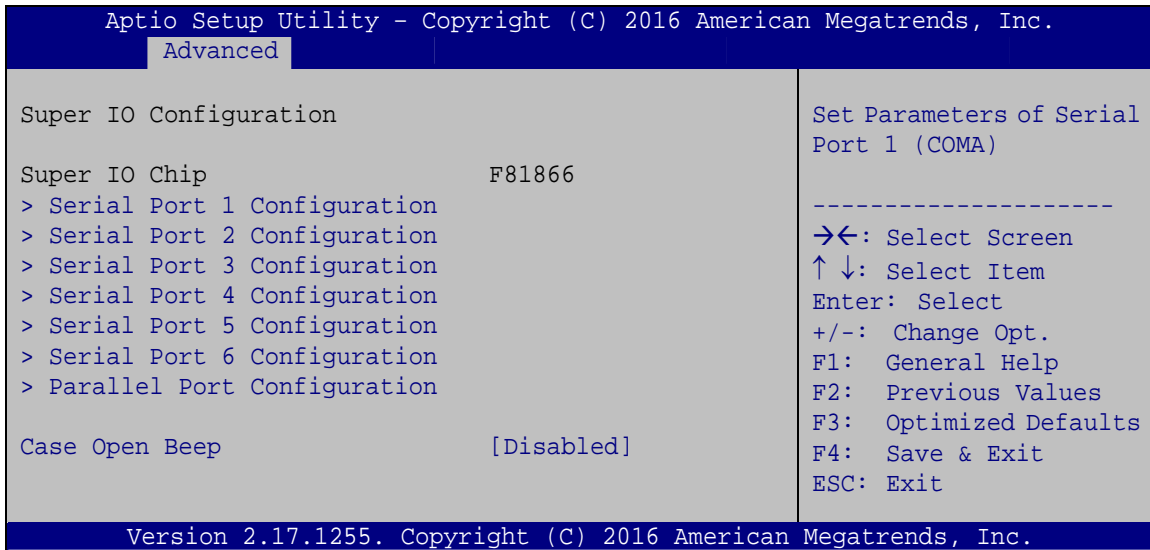

#### BIOS Menu 5: Super IO Configuration

##### → Case Open Beep [Disabled]

Use the **Case Open Beep** option to enable or disable the case open beep function.

- **Disabled**      **DEFAULT**      Disable the case open beep function
- **Enabled**                      Enable the case open beep function

## IMB-H110 microATX Motherboard

### 5.3.3.1 Serial Port 1 ~ 6 Configuration

Use the **Serial Port 1 ~ 6 Configuration** menu (**BIOS Menu 6**) to configure the serial ports.

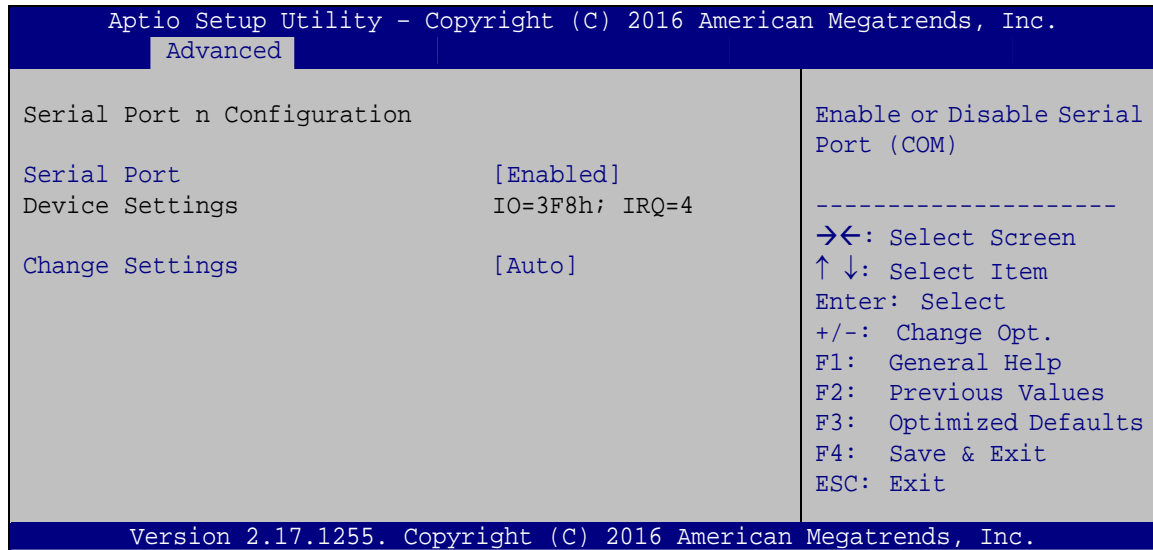

#### BIOS Menu 6: Serial Port 1 ~ 6 Configuration Menu

### 5.3.3.2 Serial Port 1 Configuration

#### → Serial Port [Enabled]

Use the **Serial Port** option to enable or disable the serial port.

- **Disabled**                      Disable the serial port
- **Enabled**      **DEFAULT**      Enable the serial port

#### → Change Settings [Auto]

Use the **Change Settings** option to change the serial port IO port address and interrupt address.

- **Auto**              **DEFAULT**      The serial port IO port address and interrupt address are automatically detected.
- **IO=3F8h;**  
**IRQ=4**                      Serial Port I/O port address is 3F8h and the interrupt address is IRQ4



- **IO=3F8h;**  
**IRQ=3, 4, 11**      Serial Port I/O port address is 3F8h and the interrupt address is IRQ3, 4, 11
- **IO=2F8h;**  
**IRQ=3, 4, 11**      Serial Port I/O port address is 2F8h and the interrupt address is IRQ3, 4, 11
- **IO=3E8h;**  
**IRQ=3, 4, 11**      Serial Port I/O port address is 3E8h and the interrupt address is IRQ3, 4, 11
- **IO=2E8h;**  
**IRQ=3, 4, 11**      Serial Port I/O port address is 2E8h and the interrupt address is IRQ3, 4, 11
- **IO=2D0h;**  
**IRQ=3, 4, 11**      Serial Port I/O port address is 2D0h and the interrupt address is IRQ3, 4, 11
- **IO=2E0h;**  
**IRQ=3, 4, 11**      Serial Port I/O port address is 2E0h and the interrupt address is IRQ3, 4, 11

### 5.3.3.3 Serial Port 2 Configuration

#### → Serial Port [Enabled]

Use the **Serial Port** option to enable or disable the serial port.

- **Disabled**      Disable the serial port
- **Enabled**      **DEFAULT**      Enable the serial port

#### → Change Settings [Auto]

Use the **Change Settings** option to change the serial port IO port address and interrupt address.

- **Auto**      **DEFAULT**      The serial port IO port address and interrupt address are automatically detected.
- **IO=2F8h;**  
**IRQ=3**      Serial Port I/O port address is 2F8h and the interrupt address is IRQ3

## IMB-H110 microATX Motherboard

- **IO=3F8h;**  
**IRQ=3, 4, 11**      Serial Port I/O port address is 3F8h and the interrupt address is IRQ3, 4, 11
- **IO=2F8h;**  
**IRQ=3, 4, 11**      Serial Port I/O port address is 2F8h and the interrupt address is IRQ3, 4, 11
- **IO=3E8h;**  
**IRQ=3, 4, 11**      Serial Port I/O port address is 3E8h and the interrupt address is IRQ3, 4, 11
- **IO=2E8h;**  
**IRQ=3, 4, 11**      Serial Port I/O port address is 2E8h and the interrupt address is IRQ3, 4, 11
- **IO=2D0h;**  
**IRQ=3, 4, 11**      Serial Port I/O port address is 2D0h and the interrupt address is IRQ3, 4, 11
- **IO=2E0h;**  
**IRQ=3, 4, 11**      Serial Port I/O port address is 2E0h and the interrupt address is IRQ3, 4, 11

### 5.3.3.4 Serial Port 3 Configuration

#### → Serial Port [Enabled]

Use the **Serial Port** option to enable or disable the serial port.

- **Disabled**      Disable the serial port
- **Enabled**      **DEFAULT**      Enable the serial port

#### → Change Settings [Auto]

Use the **Change Settings** option to change the serial port IO port address and interrupt address.

- **Auto**      **DEFAULT**      The serial port IO port address and interrupt address are automatically detected.
- **IO=3E8h;**  
**IRQ=11**      Serial Port I/O port address is 3E8h and the interrupt address is IRQ11
- **IO=3F8h;**  
**IRQ=3, 4, 11**      Serial Port I/O port address is 3F8h and the interrupt address is IRQ3, 4, 11

- **IO=2F8h;**  
**IRQ=3, 4, 11**      Serial Port I/O port address is 2F8h and the interrupt address is IRQ3, 4, 11
- **IO=3E8h;**  
**IRQ=3, 4, 11**      Serial Port I/O port address is 3E8h and the interrupt address is IRQ3, 4, 11
- **IO=2E8h;**  
**IRQ=3, 4, 11**      Serial Port I/O port address is 2E8h and the interrupt address is IRQ3, 4, 11
- **IO=2D0h;**  
**IRQ=3, 4, 11**      Serial Port I/O port address is 2D0h and the interrupt address is IRQ3, 4, 11
- **IO=2E0h;**  
**IRQ=3, 4, 11**      Serial Port I/O port address is 2E0h and the interrupt address is IRQ3, 4, 11

### 5.3.3.4.1 Serial Port 4 Configuration

#### → Serial Port [Enabled]

Use the **Serial Port** option to enable or disable the serial port.

- **Disabled**      Disable the serial port
- **Enabled**      **DEFAULT**      Enable the serial port

#### → Change Settings [Auto]

Use the **Change Settings** option to change the serial port IO port address and interrupt address.

- **Auto**      **DEFAULT**      The serial port IO port address and interrupt address are automatically detected.
- **IO=2E8h;**  
**IRQ=11**      Serial Port I/O port address is 2E8h and the interrupt address is IRQ11
- **IO=3F8h;**  
**IRQ=3, 4, 11**      Serial Port I/O port address is 3F8h and the interrupt address is IRQ3, 4, 11
- **IO=2F8h;**  
**IRQ=3, 4, 11**      Serial Port I/O port address is 2F8h and the interrupt address is IRQ3, 4, 11

## IMB-H110 microATX Motherboard

- ➔ **IO=3E8h;**  
**IRQ=3, 4, 11**      Serial Port I/O port address is 3E8h and the interrupt address is IRQ3, 4, 11
- ➔ **IO=2E8h;**  
**IRQ=3, 4, 11**      Serial Port I/O port address is 2E8h and the interrupt address is IRQ3, 4, 11
- ➔ **IO=2D0h;**  
**IRQ=3, 4, 11**      Serial Port I/O port address is 2D0h and the interrupt address is IRQ3, 4, 11
- ➔ **IO=2E0h;**  
**IRQ=3, 4, 11**      Serial Port I/O port address is 2E0h and the interrupt address is IRQ3, 4, 11

### 5.3.3.4.2 Serial Port 5 Configuration

#### ➔ Serial Port [Enabled]

Use the **Serial Port** option to enable or disable the serial port.

- ➔ **Disabled**      Disable the serial port
- ➔ **Enabled**      **DEFAULT**      Enable the serial port

#### ➔ Change Settings [Auto]

Use the **Change Settings** option to change the serial port IO port address and interrupt address.

- ➔ **Auto**      **DEFAULT**      The serial port IO port address and interrupt address are automatically detected.
- ➔ **IO=2D0h;**  
**IRQ=11**      Serial Port I/O port address is 2D0h and the interrupt address is IRQ11
- ➔ **IO=3F8h;**  
**IRQ=3, 4, 11**      Serial Port I/O port address is 3F8h and the interrupt address is IRQ3, 4, 11
- ➔ **IO=2F8h;**  
**IRQ=3, 4, 11**      Serial Port I/O port address is 2F8h and the interrupt address is IRQ3, 4, 11
- ➔ **IO=3E8h;**  
**IRQ=3, 4, 11**      Serial Port I/O port address is 3E8h and the interrupt address is IRQ3, 4, 11

- **IO=2E8h;**  
**IRQ=3, 4, 11**      Serial Port I/O port address is 2E8h and the interrupt address is IRQ3, 4, 11
- **IO=2D0h;**  
**IRQ=3, 4, 11**      Serial Port I/O port address is 2D0h and the interrupt address is IRQ3, 4, 11
- **IO=2E0h;**  
**IRQ=3, 4, 11**      Serial Port I/O port address is 2E0h and the interrupt address is IRQ3, 4, 11

### → Transfer Mode [RS232]

The serial port 5 allows setting the data transfer mode to RS-232, RS-422 or RS-485.

### 5.3.3.4.3 Serial Port 6 Configuration

#### → Serial Port [Enabled]

Use the **Serial Port** option to enable or disable the serial port.

- **Disabled**      Disable the serial port
- **Enabled**      **DEFAULT**      Enable the serial port

#### → Change Settings [Auto]

Use the **Change Settings** option to change the serial port IO port address and interrupt address.

- **Auto**      **DEFAULT**      The serial port IO port address and interrupt address are automatically detected.
- **IO=2E0h;**  
**IRQ=11**      Serial Port I/O port address is 2E0h and the interrupt address is IRQ11
- **IO=3F8h;**  
**IRQ=3, 4, 11**      Serial Port I/O port address is 3F8h and the interrupt address is IRQ3, 4, 11
- **IO=2F8h;**  
**IRQ=3, 4, 11**      Serial Port I/O port address is 2F8h and the interrupt address is IRQ3, 4, 11
- **IO=3E8h;**  
**IRQ=3, 4, 11**      Serial Port I/O port address is 3E8h and the interrupt address is IRQ3, 4, 11

## IMB-H110 microATX Motherboard

- ➔ **IO=2E8h;** Serial Port I/O port address is 2E8h and the interrupt address is IRQ3, 4, 11
- ➔ **IO=2D0h;** Serial Port I/O port address is 2D0h and the interrupt address is IRQ3, 4, 11
- ➔ **IO=2E0h;** Serial Port I/O port address is 2E0h and the interrupt address is IRQ3, 4, 11

### ➔ Transfer Mode [RS232]

The serial port 6 allows setting the data transfer mode to RS-232, RS-422 or RS-485.

### 5.3.3.5 Parallel Port Configuration

Use the **Parallel Port Configuration** menu (**BIOS Menu 7**) to configure the parallel port.

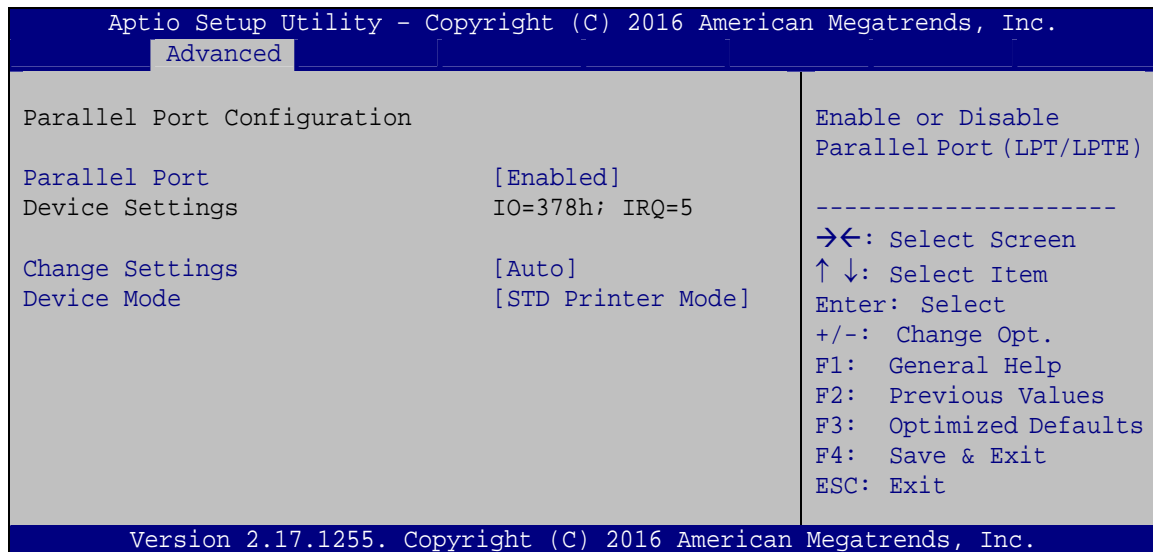

### BIOS Menu 7: Parallel Port Configuration Menu

### ➔ Parallel Port [Enabled]

Use the **Parallel Port** option to enable or disable the parallel port.

- ➔ **Disabled** Disable the parallel port
- ➔ **Enabled** **DEFAULT** Enable the parallel port

### → Change Settings [Auto]

Use the **Change Settings** option to change the parallel port IO port address and interrupt address.

- |   |  |                |   |
|---|--|----------------|---|
| → | <b>Auto</b>  | <b>DEFAULT</b> | The parallel port IO port address and interrupt address are automatically detected.           |
| → | <b>IO=378h;<br/>IRQ=5</b>                          |                | Parallel Port I/O port address is 378h and the interrupt address is IRQ5                      |
| → | <b>IO=378h;<br/>IRQ=5, 6, 7,<br/>9, 10, 11, 12</b> |                | Parallel Port I/O port address is 378h and the interrupt address is IRQ5, 6, 7, 9, 10, 11, 12 |
| → | <b>IO=278h;<br/>IRQ=5, 6, 7,<br/>9, 10, 11, 12</b> |                | Parallel Port I/O port address is 278h and the interrupt address is IRQ5, 6, 7, 9, 10, 11, 12 |
| → | <b>IO=3BCh;<br/>IRQ=5, 6, 7,<br/>9, 10, 11, 12</b> |                | Parallel Port I/O port address is 3BCh and the interrupt address is IRQ5, 6, 7, 9, 10, 11, 12 |

### → Device Mode [STD Printer Mode]

Use the **Device Mode** option to select the mode the parallel port operates in. Configuration options are listed below.

- |   |                      |                |
|---|----------------------|----------------|
| ▪ | STD Printer Mode     | <b>Default</b> |
| ▪ | SPP Mode             |                |
| ▪ | EPP-1.9 and SPP Mode |                |
| ▪ | EPP-1.7 and SPP Mode |                |
| ▪ | ECP Mode             |                |
| ▪ | ECP and EPP 1.9 Mode |                |
| ▪ | ECP and EPP 1.7 Mode |                |

## IMB-H110 microATX Motherboard

### 5.3.4 F81866SEC Super IO Configuration

Use the **F81866SEC Super IO Configuration** menu (**BIOS Menu 8**) to set or change the configurations for the serial ports.

```

Aptio Setup Utility - Copyright (C) 2016 American Megatrends, Inc.
  Advanced
F81866SEC Super IO Configuration
Super IO Chip                F81866SEC
> Serial Port 7 Configuration
> Serial Port 8 Configuration
> Serial Port 9 Configuration
> Serial Port 10 Configuration
> Serial Port 11 Configuration
> Serial Port 12 Configuration

Set Parameters of Serial
Port 7
-----
-><: Select Screen
↑↓: Select Item
Enter: Select
+/-: Change Opt.
F1: General Help
F2: Previous Values
F3: Optimized Defaults
F4: Save & Exit
ESC: Exit

Version 2.17.1255. Copyright (C) 2016 American Megatrends, Inc.
  
```

**BIOS Menu 8: F81866SEC Super IO Configuration**

#### 5.3.4.1 Serial Port 7~12 Configuration

Use the **Serial Port 7~12 Configuration** menu (**BIOS Menu 9**) to configure the serial ports.

```

Aptio Setup Utility - Copyright (C) 2016 American Megatrends, Inc.
  Advanced
Serial Port n Configuration
Serial Port                  [Enabled]
Device Settings              IO=240h; IRQ=10

Enable or Disable Serial
Port (COM)
-----
-><: Select Screen
↑↓: Select Item
Enter: Select
+/-: Change Opt.
F1: General Help
F2: Previous Values
F3: Optimized Defaults
F4: Save & Exit
ESC: Exit

Version 2.17.1255. Copyright (C) 2016 American Megatrends, Inc.
  
```

**BIOS Menu 9: Serial Port 7~12 Configuration Menu**



### ➔ Serial Port [Enabled]

Use the **Serial Port** option to enable or disable the serial port.

- ➔ **Disabled**                      Disable the serial port
- ➔ **Enabled**      **DEFAULT**      Enable the serial port

### 5.3.5 iWDD H/W Monitor

The **iWDD H/W Monitor** menu (**BIOS Menu 10**) contains the fan configuration submenu, and displays operating temperature, fan speeds and system voltages.

```

Aptio Setup Utility - Copyright (C) 2016 American Megatrends, Inc.
Advanced
PC Health Status
CPU temperature           : +49°C
SYS temperature          : +34°C

CPU_FAN1 Speed           : 761 RPM
SYS_FAN1 Speed           : N/A

CPU_CORE                  : +1.143 V
+5V                       : +5.070 V
+12V                      : +12.096 V
+DDR                      : +1.202 V
+5VSB                     : +5.052 V
+3.3V                     : +3.343 V
+3.3VSB                   : +3.282 V

> Smart Fan Mode Configuration

Smart Fan Mode Select

-----
-><: Select Screen
↑↓: Select Item
Enter: Select
+/-: Change Opt.
F1: General Help
F2: Previous Values
F3: Optimized Defaults
F4: Save & Exit
ESC: Exit

Version 2.17.1255. Copyright (C) 2016 American Megatrends, Inc.
    
```

### BIOS Menu 10: iWDD H/W Monitor

#### ➔ PC Health Status

The following system parameters and values are shown. The system parameters that are monitored are:

- System Temperatures:
  - CPU Temperature
  - System Temperature
- Fan Speed:
  - CPU Fan Speed
  - System Fan Speed

## IMB-H110 microATX Motherboard

- Voltages:
  - CPU\_CORE
  - +5V
  - +12V
  - +DDR
  - +5VSB
  - +3.3V
  - +3.3VSB

### 5.3.5.1 Smart Fan Mode Configuration

Use the **Smart Fan Mode Configuration** submenu (**BIOS Menu 11**) to configure the CPU/system fan temperature and speed settings.

```

Aptio Setup Utility - Copyright (C) 2016 American Megatrends, Inc.
Advanced
Smart Fan Mode Configuration
CPU_FAN1 Smart Fan Control      [Auto Mode]
Auto mode fan start temperature 50
Auto mode fan off temperature   40
Auto mode fan start PWM        30
Auto mode fan slope PWM        1

SYS_FAN1 Smart Fan Control      [Auto Mode]
Auto mode fan start temperature 50
Auto mode fan off temperature   40
Auto mode fan start PWM        30
Auto mode fan slope PWM        1

Smart Fan Mode Select
-----
-><: Select Screen
↑↓: Select Item
Enter: Select
+/-: Change Opt.
F1: General Help
F2: Previous Values
F3: Optimized Defaults
F4: Save & Exit
ESC: Exit

Version 2.17.1255. Copyright (C) 2016 American Megatrends, Inc.
  
```

#### BIOS Menu 11: Smart Fan Mode Configuration

##### → CPU\_FAN1 Smart Fan Control/SYS\_FAN1 Smart Fan Control [Auto Mode]

Use the **CPU\_FAN1 Smart Fan Control/SYS\_FAN1 Smart Fan Control** option to configure the CPU/System Smart Fan.

- **Auto Mode**      **DEFAULT**      The fan adjusts its speed using Auto Mode settings.
- **Manual Mode**      The fan spins at the speed set in Manual Mode settings.

➔ **Auto mode fan start/off temperature**

Use the + or – key to change the **Auto mode fan start/off temperature** value. Enter a decimal number between 1 and 100.

➔ **Auto mode fan start PWM**

Use the + or – key to change the **Auto mode fan start PWM** value. Enter a decimal number between 1 and 100.

➔ **Auto mode fan slope PWM**

Use the + or – key to change the **Auto mode fan slope PWM** value. Enter a decimal number between 1 and 64.

### 5.3.6 RTC Wake Settings

The **RTC Wake Settings** menu (**BIOS Menu 12**) enables the system to wake at the specified time.

```

Aptio Setup Utility - Copyright (C) 2016 American Megatrends, Inc.
  Advanced
Wake system with Fixed Time      [Disabled]
                                     Enable or disable System
                                     wake on alarm event. When
                                     enabled, System will
                                     wake on the
                                     date::hr::min::sec
                                     specified
-----
➔←: Select Screen
↑↓: Select Item
Enter: Select
+/-: Change Opt.
F1:  General Help
F2:  Previous Values
F3:  Optimized Defaults
F4:  Save & Exit
ESC: Exit
Version 2.17.1255. Copyright (C) 2016 American Megatrends, Inc.
    
```

**BIOS Menu 12: RTC Wake Settings**

## IMB-H110 microATX Motherboard

### → Wake system with Fixed Time [Disabled]

Use the **Wake system with Fixed Time** option to enable or disable the system wake on alarm event.

→ **Disabled**      **DEFAULT**      The real time clock (RTC) cannot generate a wake event.

→ **Enabled**      If selected, the **Wake up every day** option appears allowing you to enable to disable the system to wake every day at the specified time. Besides, the following options appear with values that can be selected:

Wake up date

Wake up hour

Wake up minute

Wake up second

After setting the alarm, the computer turns itself on from a suspend state when the alarm goes off.

### 5.3.7 Serial Port Console Redirection

The **Serial Port Console Redirection** menu (**BIOS Menu 13**) allows the console redirection options to be configured. Console redirection allows users to maintain a system remotely by re-directing keyboard input and text output through the serial port.

```

Aptio Setup Utility - Copyright (C) 2016 American Megatrends, Inc.
  Advanced
  COM1
  Console Redirection [Disabled] Console Redirection
  > Console Redirection Settings Enable or Disable

  COM2
  Console Redirection [Disabled]
  > Console Redirection Settings

  COM3
  Console Redirection [Disabled]
  > Console Redirection Settings

  COM4
  Console Redirection [Disabled]
  > Console Redirection Settings

  COM5
  Console Redirection [Disabled]
  > Console Redirection Settings

  COM6
  Console Redirection [Disabled]
  > Console Redirection Settings

  COM7
  Console Redirection [Disabled]
  > Console Redirection Settings

  COM8
  Console Redirection [Disabled]
  > Console Redirection Settings

  COM9
  Console Redirection [Disabled]
  > Console Redirection Settings

  COM10
  Console Redirection [Disabled]
  > Console Redirection Settings

  Legacy Console Redirection
  > Legacy Console Redirection Settings

-----
-><: Select Screen
↑↓: Select Item
Enter: Select
+/-: Change Opt.
F1: General Help
F2: Previous Values
F3: Optimized Defaults
F4: Save & Exit
ESC: Exit
  
```

Version 2.17.1255. Copyright (C) 2016 American Megatrends, Inc.

**BIOS Menu 13: Serial Port Console Redirection**

## IMB-H110 microATX Motherboard

### → Console Redirection [Disabled]

Use **Console Redirection** option to enable or disable the console redirection function.

- **Disabled**      **DEFAULT**      Disabled the console redirection function
- **Enabled**                      Enabled the console redirection function

The following options are available in the **Console Redirection Settings** submenu when the **Console Redirection** option is enabled.

### → Terminal Type [ANSI]

Use the **Terminal Type** option to specify the remote terminal type.

- **VT100**                      The target terminal type is VT100
- **VT100+**                      The target terminal type is VT100+
- **VT-UTF8**                      The target terminal type is VT-UTF8
- **ANSI**                      **DEFAULT**      The target terminal type is ANSI

### → Bits per second [115200]

Use the **Bits per second** option to specify the serial port transmission speed. The speed must match the other side. Long or noisy lines may require lower speeds.

- **9600**                      Sets the serial port transmission speed at 9600.
- **19200**                      Sets the serial port transmission speed at 19200.
- **57600**                      Sets the serial port transmission speed at 57600.
- **115200**                      **DEFAULT**      Sets the serial port transmission speed at 115200.

### → Data Bits [8]

Use the **Data Bits** option to specify the number of data bits.

- **7**                      Sets the data bits at 7.
- **8**                      **DEFAULT**      Sets the data bits at 8.

**→ Parity [None]**

Use the **Parity** option to specify the parity bit that can be sent with the data bits for detecting the transmission errors.

- |                |                |   |
|----------------|----------------|---|
| <b>→ None</b>  | <b>DEFAULT</b> | No parity bit is sent with the data bits.                                 |
| <b>→ Even</b>  |                | The parity bit is 0 if the number of ones in the data bits is even.       |
| <b>→ Odd</b>   |                | The parity bit is 0 if the number of ones in the data bits is odd.        |
| <b>→ Mark</b>  |                | The parity bit is always 1. This option does not provide error detection. |
| <b>→ Space</b> |                | The parity bit is always 0. This option does not provide error detection. |

**→ Stop Bits [1]**

Use the **Stop Bits** option to specify the number of stop bits used to indicate the end of a serial data packet. Communication with slow devices may require more than 1 stop bit.

- |            |                |                                    |
|------------|----------------|------------------------------------|
| <b>→ 1</b> | <b>DEFAULT</b> | Sets the number of stop bits at 1. |
| <b>→ 2</b> |                | Sets the number of stop bits at 2. |

## IMB-H110 microATX Motherboard

### 5.3.7.1 Legacy Console Redirection Settings

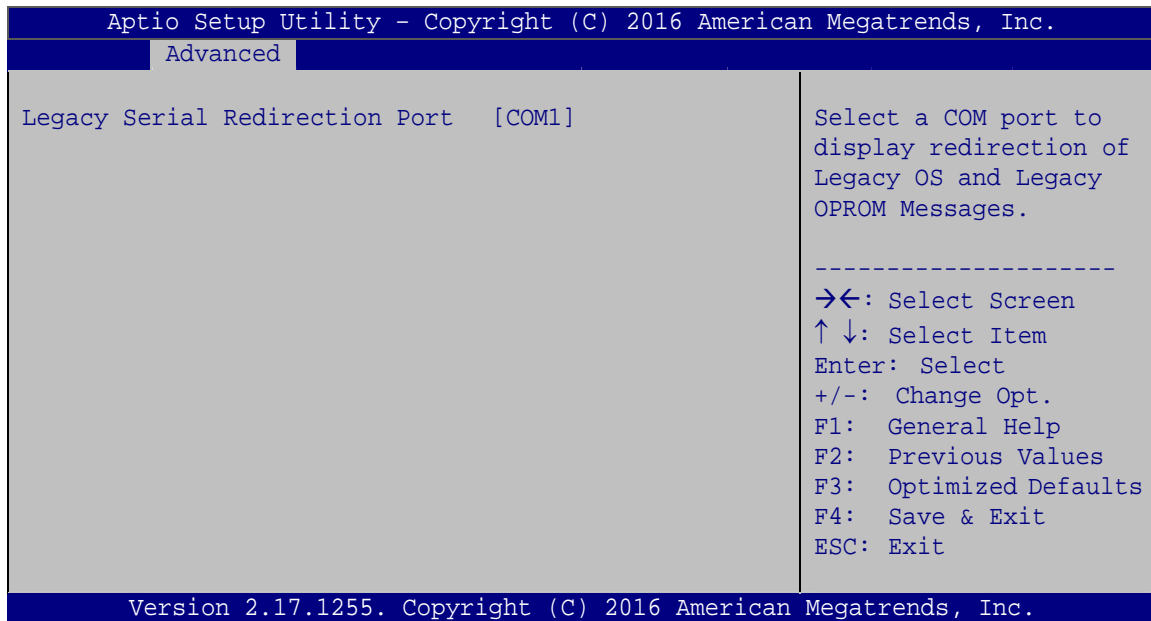

#### BIOS Menu 14: Legacy Console Redirection Settings

##### → Legacy Serial Redirection Port [COM1]

Use the Legacy Serial Redirection Port option to select a COM port to display redirection of legacy OS and legacy OPRM messages.

### 5.3.8 CPU Configuration

Use the **CPU Configuration** menu (**BIOS Menu 15**) to view detailed CPU specifications or enable the Intel Virtualization Technology.



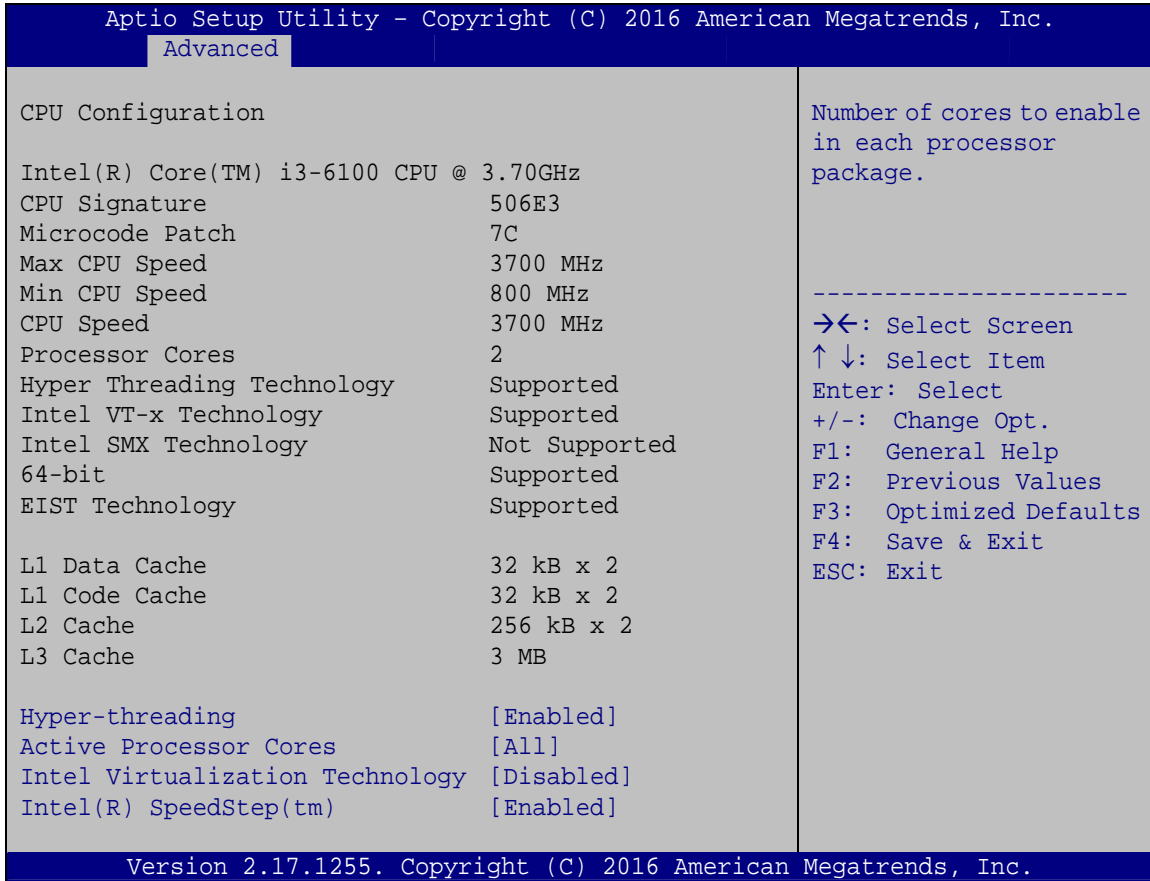

### BIOS Menu 15: CPU Configuration

#### → Hyper-threading [Enabled]

Use the **Hyper-threading** BIOS option to enable or disable the Intel Hyper-Threading Technology.

→ **Disabled** Disables the Intel Hyper-Threading Technology.

→ **Enabled** **DEFAULT** Enables the Intel Hyper-Threading Technology.

#### → Active Processor Cores [All]

Use the **Active Processor Cores** BIOS option to enable numbers of cores in the processor package.

→ **All** **DEFAULT** Enable all cores in the processor package.

→ **1** Enable one core in the processor package.

## IMB-H110 microATX Motherboard

### → Intel Virtualization Technology [Disabled]

Use the **Intel Virtualization Technology** option to enable or disable virtualization on the system. When combined with third party software, Intel® Virtualization technology allows several OSs to run on the same system at the same time.

- **Disabled**                      **DEFAULT**      Disables Intel Virtualization Technology.
- **Enabled**    Enables Intel Virtualization Technology.

### → Intel(R) SpeedStep(tm) [Enabled]

Use the **Intel(R) SpeedStep(tm)** option to enable or disable the Intel® SpeedStep Technology which allows more than two frequency ranges to be supported.

- **Disabled**    Disables Intel® SpeedStep Technology
- **Enabled**    **DEFAULT**      Enables Intel® SpeedStep Technology

## 5.3.9 SATA Configuration

Use the **SATA Configuration** menu (**BIOS Menu 16**) to change and/or set the configuration of the SATA devices installed in the system.

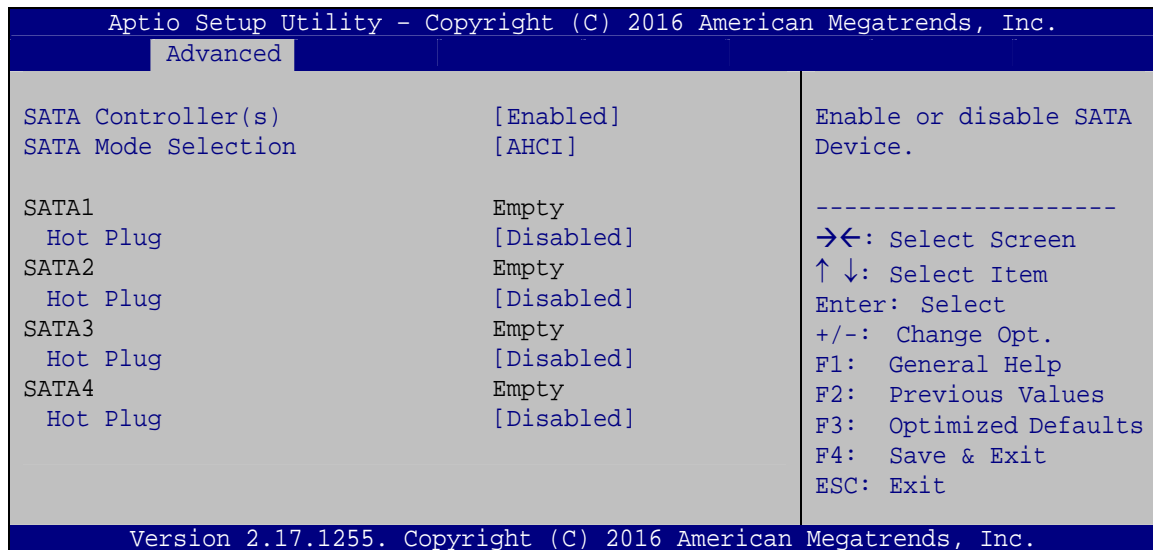

**BIOS Menu 16: SATA Configuration**

### → SATA Controller(s) [Enabled]

Use the **SATA Controller(s)** option to configure the SATA controller(s).

- **Enabled**      **DEFAULT**      Enables the on-board SATA controller(s).
- **Disabled**                      Disables the on-board SATA controller(s).

### → SATA Mode Selection [AHCI]

Use the **SATA Mode Selection** option to determine how the SATA devices operate.

- **AHCI**              **DEFAULT**      Configures SATA devices as AHCI device.
- **RAID**                      Configures SATA devices as RAID device.

### → Hot Plug [Disabled]

Use the **Hot Plug** option to designate the correspondent SATA port as hot-pluggable.

- **Disabled**      **DEFAULT**      Disables the hot-pluggable function of the SATA port.
- **Enabled**                      Designates the SATA port as hot-pluggable.

## 5.3.10 NVMe Configuration

Use the **NVMe Configuration (BIOS Menu 17)** menu to display the NVMe controller and device information.

```

Aptio Setup Utility - Copyright (C) 2016 American Megatrends, Inc.
-----
Advanced
-----
NVMe controller and Drive information
No NVMe Device Found

-----
→←: Select Screen
↑↓: Select Item
Enter: Select
+/-: Change Opt.
F1: General Help
F2: Previous Values
F3: Optimized Defaults
F4: Save & Exit
ESC: Exit
-----
Version 2.17.1255. Copyright (C) 2016 American Megatrends, Inc.
    
```

**BIOS Menu 17: NVMe Configuration**

## IMB-H110 microATX Motherboard

### 5.3.11 USB Configuration

Use the **USB Configuration** menu (**BIOS Menu 18**) to read USB configuration information and configure the USB settings.

```

Aptio Setup Utility - Copyright (C) 2016 American Megatrends, Inc.
  Advanced
USB Configuration
USB Controllers:
  1 XHCI
USB Devices:
  1 Keyboard, 1 Hub
Legacy USB Support          [Enabled]
-----
-><: Select Screen
↑ ↓: Select Item
Enter: Select
+/-: Change Opt.
F1:  General Help
F2:  Previous Values
F3:  Optimized Defaults
F4:  Save & Exit
ESC: Exit
Version 2.17.1255. Copyright (C) 2016 American Megatrends, Inc.
  
```

#### BIOS Menu 18: USB Configuration

##### ➔ Legacy USB Support [Enabled]

Use the **Legacy USB Support** BIOS option to enable USB mouse and USB keyboard support. Normally if this option is not enabled, any attached USB mouse or USB keyboard does not become available until a USB compatible operating system is fully booted with all USB drivers loaded. When this option is enabled, any attached USB mouse or USB keyboard can control the system even when there is no USB driver loaded onto the system.

- ➔ **Enabled**      **DEFAULT**      Legacy USB support enabled
- ➔ **Disabled**                      Legacy USB support disabled
- ➔ **Auto**                              Legacy USB support disabled if no USB devices are connected

### 5.3.12 iEi Feature

Use the **iEi Feature** menu (**BIOS Menu 19**) to configure One Key Recovery function.

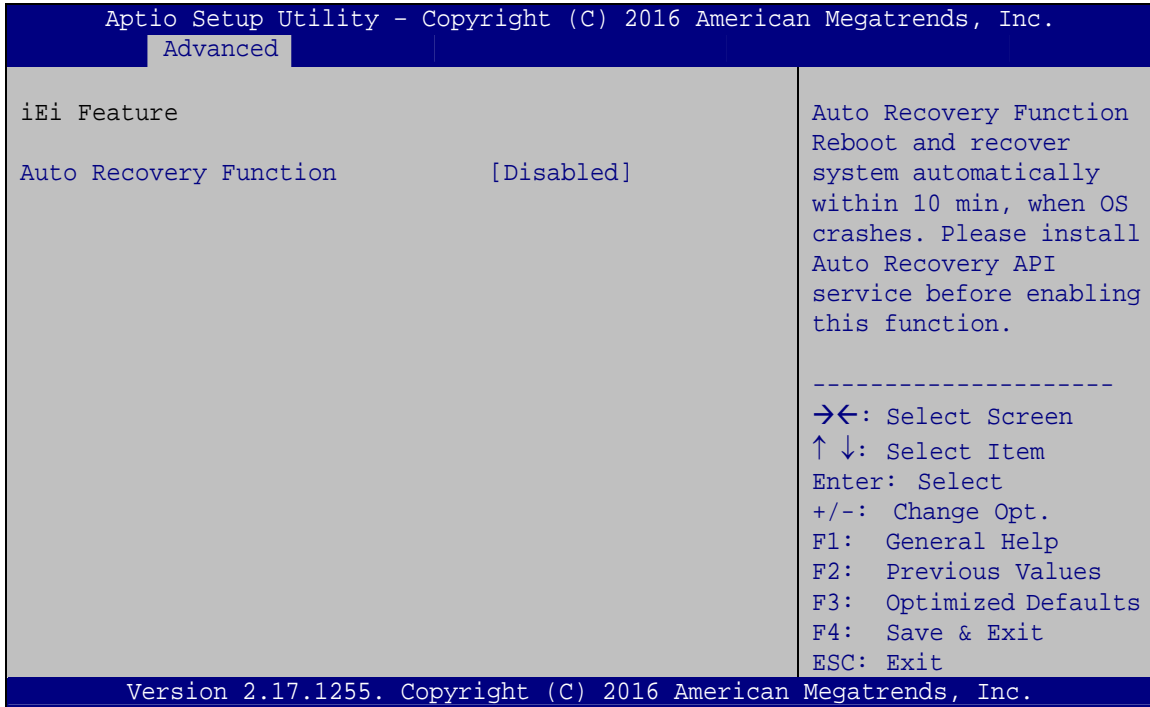

#### BIOS Menu 19: iEi Feature

##### → Auto Recovery Function [Disabled]

Use the **Auto Recovery Function** BIOS option to enable or disable the auto recovery function of the IEI One Key Recovery.

- **Disabled**      **DEFAULT**      Auto recovery function disabled
- **Enabled**        Auto recovery function enabled

## IMB-H110 microATX Motherboard

### 5.4 Chipset

Use the **Chipset** menu (**BIOS Menu 20**) to access the PCH IO and System Agent (SA) configuration menus.



#### **WARNING!**

Setting the wrong values for the Chipset BIOS selections in the Chipset BIOS menu may cause the system to malfunction.

```

Aptio Setup Utility - Copyright (C) 2016 American Megatrends, Inc.
Main   Advanced  Chipset  Security  Boot   Save & Exit
-----
> System Agent (SA) Configuration      System Agent (SA)
> PCH-IO Configuration                Parameters
-----
-><: Select Screen
↑ ↓: Select Item
Enter: Select
+/-: Change Opt.
F1: General Help
F2: Previous Values
F3: Optimized Defaults
F4: Save & Exit
ESC: Exit

Version 2.17.1255. Copyright (C) 2016 American Megatrends, Inc.
    
```

**BIOS Menu 20: Chipset**

### 5.4.1 System Agent (SA) Configuration

Use the **System Agent (SA) Configuration** menu (**BIOS Menu 21**) to configure the System Agent (SA) parameters.

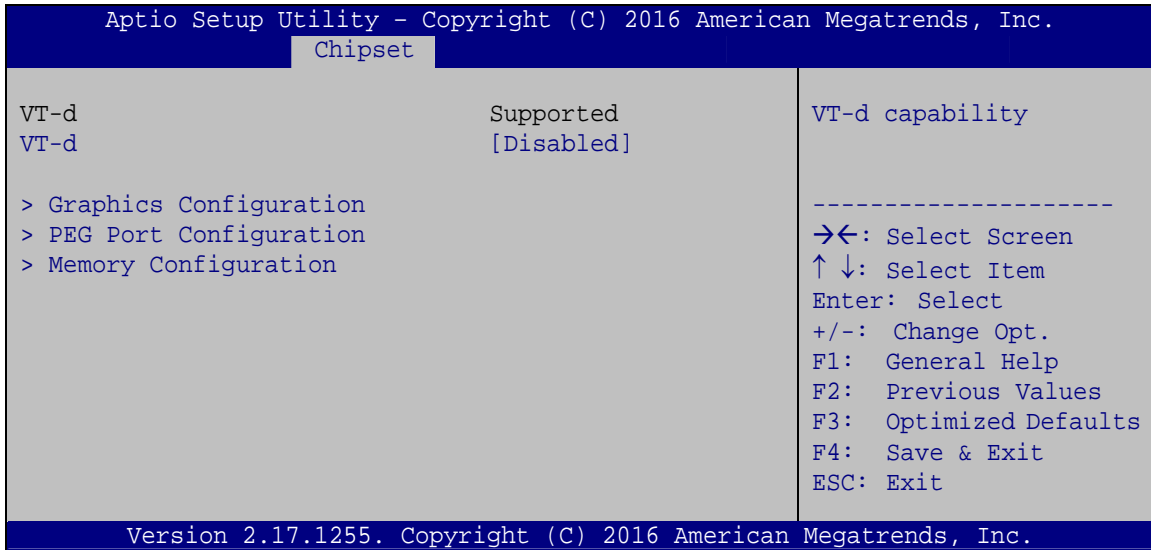

#### **BIOS Menu 21: System Agent (SA) Configuration**

##### → **VT-d [Disabled]**

Use the **VT-d** option to enable or disable VT-d capability.

- **Disabled**                      **DEFAULT**      Disables VT-d capability.
- **Enabled**    Enables VT-d capability.

## IMB-H110 microATX Motherboard

### 5.4.1.1 Graphics Configuration

Use the **Graphics Configuration (BIOS Menu 22)** menu to configure the video device connected to the system.

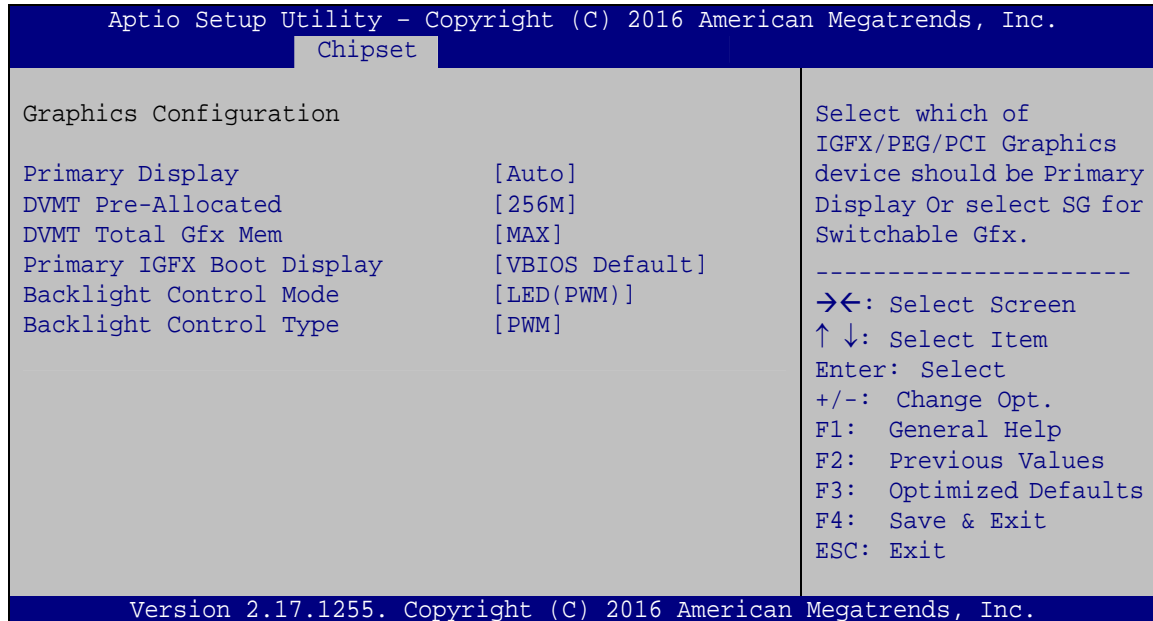

#### BIOS Menu 22: Graphics Configuration

##### → Primary Display [Auto]

Use the **Primary Display** option to select the primary graphics controller the system uses.

The following options are available:

- Auto **Default**
- IGFX
- PEG
- PCIE
- SG

##### → DVMT Pre-Allocated [256M]

Use the **DVMT Pre-Allocated** option to set the amount of system memory allocated to the integrated graphics processor when the system boots. The system memory allocated can then only be used as graphics memory, and is no longer available to applications or the operating system. Configuration options are listed below:

- 32M
- 64M



- 128M
- 256M                   **Default**
- 512M

→ **DVMT Total Gfx Mem [MAX]**

Use the **DVMT Total Gfx Mem** option to select DVMT5.0 total graphic memory size used by the internal graphic device. The following options are available:

- 128M
- 256M
- MAX                   **Default**

→ **Primary IGFX Boot Display [VBIOS Default]**

Use the **Primary IGFX Boot Display** option to select the display device used by the system when it boots. Configuration options are listed below.

- VBIOS Default       **Default**
- CRT
- DVI-VGA
- LVDS
- DVI

→ **Backlight Control Mode [LED(PWM)]**

Use the **Backlight Control Mode** BIOS option to select the LCD backlight control mode. Configuration options are listed below.

- LED(PWM)           **DEFAULT**
- CCFL(Linear)

→ **Backlight Control Type [PWM]**

Use this BIOS option to select the LCD backlight control type from **PWM** or **DC**.

## IMB-H110 microATX Motherboard

### 5.4.1.2 PEG Port Configuration

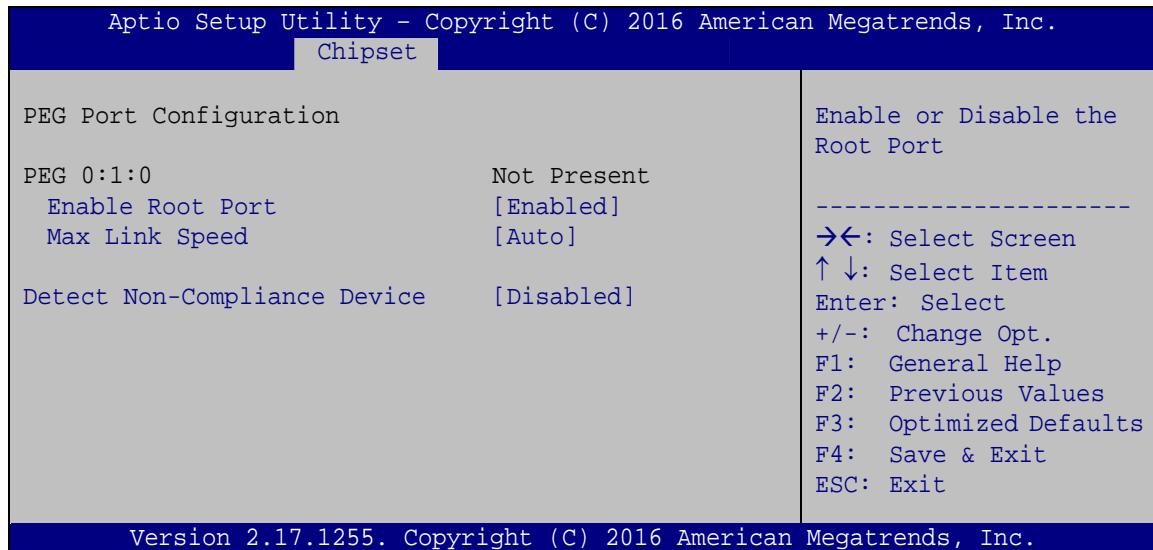

#### BIOS Menu 23: PEG Port Configuration

##### → Enable Root Port [Enabled]

Use the **Enable Root Port** option to enable or disable the PCI Express (PEG) controller.

- **Disabled** Disables the PCI Express (PEG) controller.
- **Enabled** **DEFAULT** Enables the PCI Express (PEG) controller.

##### → Max Link Speed [Auto]

Use the **Max Link Speed** option to select the maximum link speed of the PCI Express slot.

The following options are available:

- Auto **Default**
- Gen1
- Gen2
- Gen3

##### → Detect Non-Compliance Device [Disabled]

Use the **Detect Non-Compliance Device** option to enable or disable detecting if a non-compliance PCI Express device is connected to the PCI Express slot.

- ➔ **Disabled**      **DEFAULT**      Disables to detect if a non-compliance PCI Express device is connected to the PCI Express slot.
- ➔ **Enabled**      Enables to detect if a non-compliance PCI Express device is connected to the PCI Express slot.

### 5.4.1.3 Memory Configuration

Use the **Memory Configuration** submenu (**BIOS Menu 24**) to view memory information.

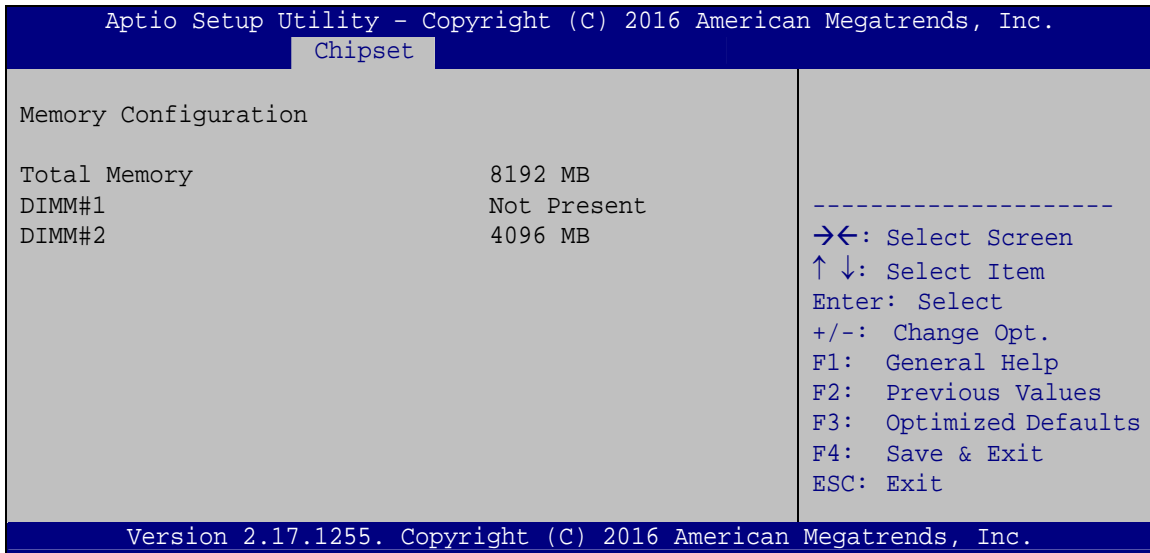

**BIOS Menu 24: Memory Configuration**

## IMB-H110 microATX Motherboard

### 5.4.2 PCH-IO Configuration

Use the **PCH-IO Configuration** menu (**BIOS Menu 25**) to configure the PCH parameters.

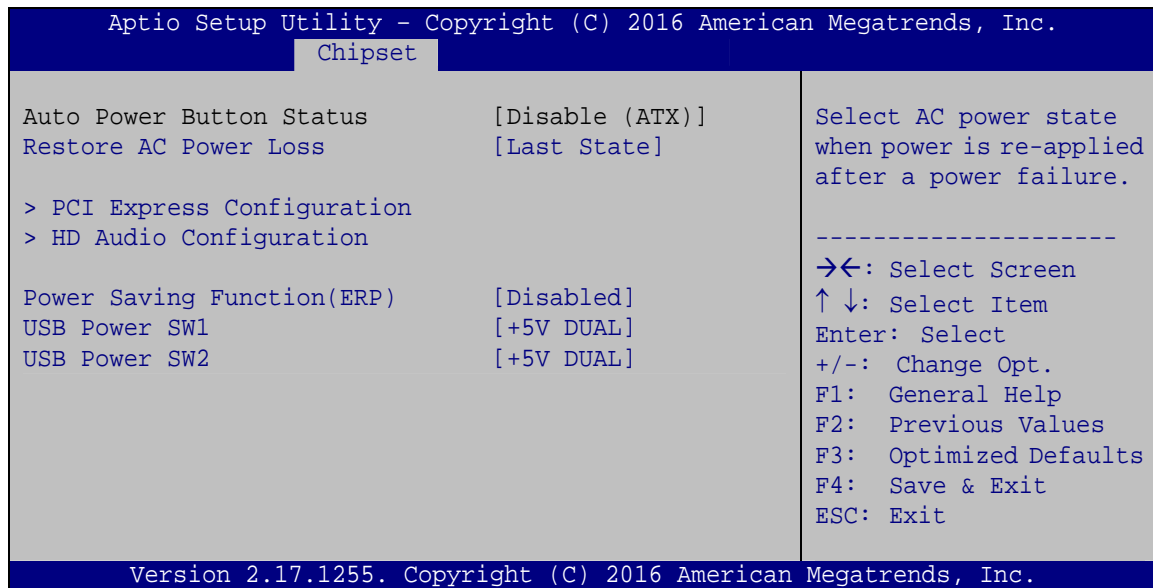

#### BIOS Menu 25: PCH-IO Configuration

##### → Restore AC Power Loss [Last State]

Use the **Restore AC Power Loss** BIOS option to specify what state the system returns to if there is a sudden loss of power to the system.

- **Power Off**                      The system remains turned off.
- **Power On**                        The system turns on.
- **Last State**    **DEFAULT**      The system returns to its previous state. If it was on, it turns itself on. If it was off, it remains off.

##### → Power Saving Function(ERP) [Disabled]

Use the **Power Saving Function(ERP)** BIOS option to enable or disable the power saving function.

- **Disabled**    **DEFAULT**      Power saving function is disabled.
- **Enabled**                          Power saving function is enabled. It will reduce power consumption when the system is off.

### → USB Power SW1 [+5V DUAL]

Use the **USB Power SW1** BIOS option to configure the USB power source for the corresponding USB connectors (**Table 5-2**).

- **+5V** Sets the USB power source to +5V
- **+5V DUAL** **DEFAULT** Sets the USB power source to +5V dual

### → USB Power SW2 [+5V DUAL]

Use the **USB Power SW2** BIOS option to configure the USB power source for the corresponding USB connectors (**Table 5-2**).

- **+5V** Sets the USB power source to +5V
- **+5V DUAL** **DEFAULT** Sets the USB power source to +5V dual

BIOS Options	Configured USB Ports
USB Power SW1	LAN1_USB1 (external USB 3.0 ports) LAN2_USB1 (external USB 3.0 ports)
USB Power SW2	USB1 (External USB 2.0 ports) H_USB1 (External USB 2.0 ports) J_USB1 (internal USB 2.0 ports)

**Table 5-2: BIOS Options and Configured USB Ports**

## IMB-H110 microATX Motherboard

### 5.4.2.1 PCI Express Configuration

Use the **PCI Express Configuration** submenu (**BIOS Menu 26**) to configure the PCIe Mini slot.

```

Aptio Setup Utility - Copyright (C) 2016 American Megatrends, Inc.
  Chipset
-----
PCI Express Configuration
> MPCIE1 Slot

MPCIE1 Slot Settings.
-----
-><: Select Screen
↑↓: Select Item
Enter: Select
+/-: Change Opt.
F1: General Help
F2: Previous Values
F3: Optimized Defaults
F4: Save & Exit
ESC: Exit

Version 2.17.1255. Copyright (C) 2016 American Megatrends, Inc.
  
```

**BIOS Menu 26: PCI Express Configuration**

#### 5.4.2.1.1 MPCIE1 Slot

```

Aptio Setup Utility - Copyright (C) 2016 American Megatrends, Inc.
  Advanced
-----
PCIe Speed [Auto]
Detect Non-Compliance Device [Disabled]

Select PCI Express port speed.
-----
-><: Select Screen
↑↓: Select Item
Enter: Select
+/-: Change Opt.
F1: General Help
F2: Previous Values
F3: Optimized Defaults
F4: Save & Exit
ESC: Exit

Version 2.17.1255. Copyright (C) 2016 American Megatrends, Inc.
  
```

**BIOS Menu 27: MPCIE1 Slot**

**→ PCIe Speed [Auto]**

Use this option to select the support type of the PCI Express slots. The following options are available:

- Auto                    **Default**
- Gen1
- Gen2
- Gen3

**→ Detect Non-Compliance Device [Disabled]**

Use the **Detect Non-Compliance Device** option to enable or disable detecting if a non-compliance PCI Express device is connected to the PCI Express slot.

- Disabled                    DEFAULT**    Disables to detect if a non-compliance PCI Express device is connected to the PCI Express slot.
  
- Enabled**                    Enables to detect if a non-compliance PCI Express device is connected to the PCI Express slot.

## IMB-H110 microATX Motherboard

### 5.4.2.2 HD Audio Configuration

Use the **HD Audio Configuration** menu (**BIOS Menu 28**) to configure the PCH Azalia settings.

```

Aptio Setup Utility - Copyright (C) 2016 American Megatrends, Inc.
Chipset
HD Audio Configuration
HD Audio [Auto]
Control Detection of the HD-Audio device.
Disable = HDA will be unconditionally disabled
Enabled = HDA will be unconditionally enabled
Auto = HDA will be enabled if present, disabled otherwise.
-----
-><: Select Screen
↑↓: Select Item
Enter: Select
+/-: Change Opt.
F1: General Help
F2: Previous Values
F3: Optimized Defaults
F4: Save & Exit
ESC: Exit
Version 2.17.1255. Copyright (C) 2016 American Megatrends, Inc.
    
```

#### BIOS Menu 28: HD Audio Configuration

##### → HD Audio [Auto]

Use the **HD Audio** option to enable or disable the High Definition Audio controller.

- **Disabled**                      The onboard High Definition Audio controller is disabled.
- **Enabled**                        The onboard High Definition Audio controller is enabled.
- **Auto**                      **DEFAULT**      The onboard High Definition Audio controller automatically detected and enabled



## 5.5 Security

Use the **Security** menu (**BIOS Menu 29**) to set system and user passwords.

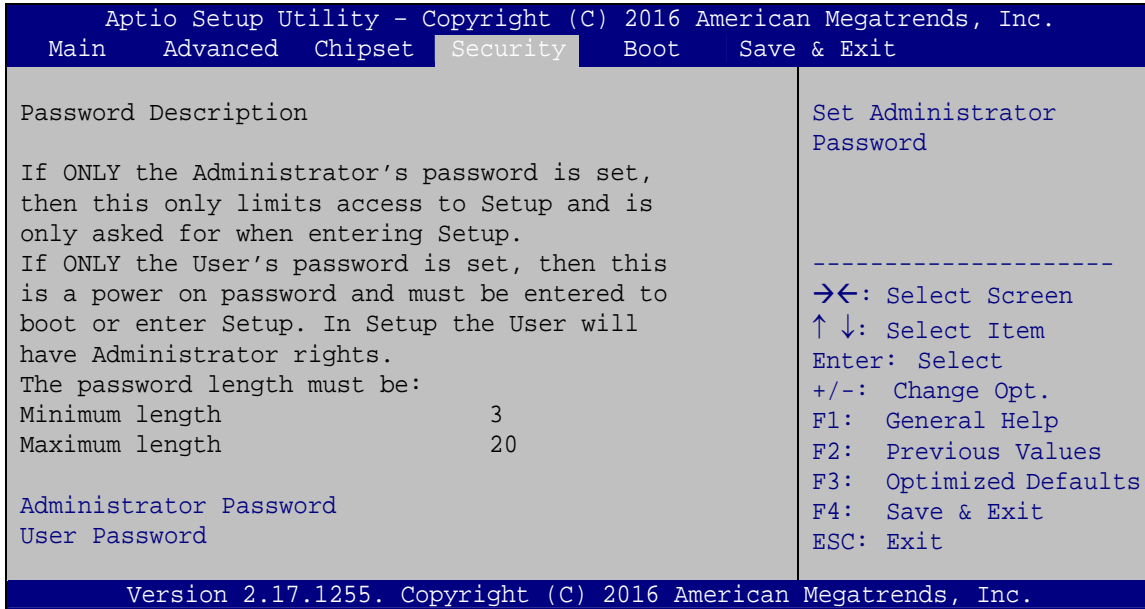

### BIOS Menu 29: Security

#### → Administrator Password

Use the **Administrator Password** to set or change a administrator password.

#### → User Password

Use the **User Password** to set or change a user password.

## IMB-H110 microATX Motherboard

### 5.6 Boot

Use the **Boot** menu (**BIOS Menu 30**) to configure system boot options.

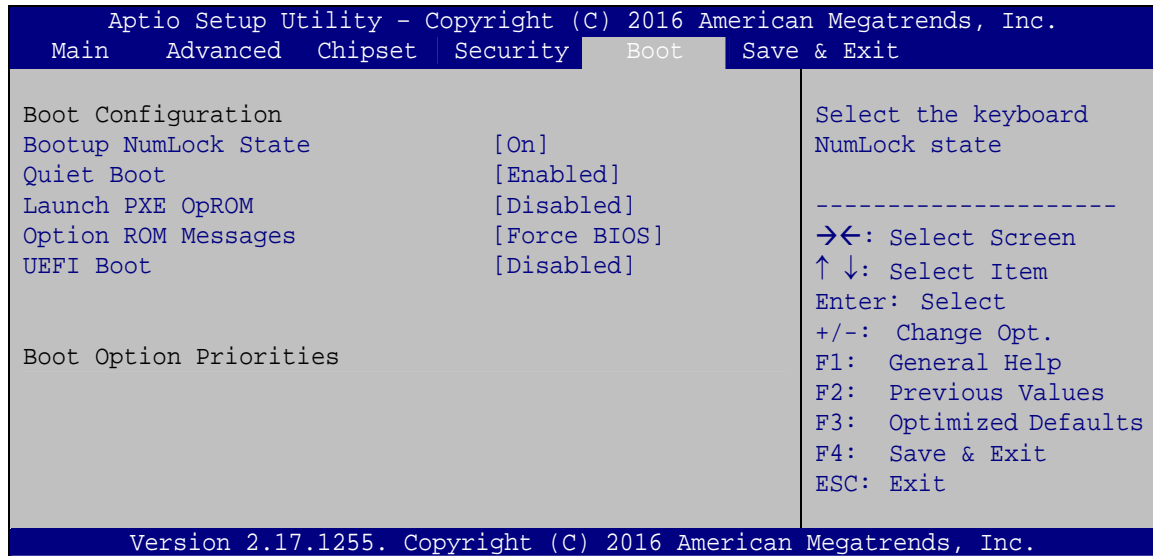

#### BIOS Menu 30: Boot

##### → Bootup NumLock State [On]

Use the **Bootup NumLock State** BIOS option to specify if the number lock setting must be modified during boot up.

- **On**                      **DEFAULT**                      Allows the Number Lock on the keyboard to be enabled automatically when the computer system boots up. This allows the immediate use of the 10-key numeric keypad located on the right side of the keyboard. To confirm this, the Number Lock LED light on the keyboard is lit.
- **Off**    Does not enable the keyboard Number Lock automatically. To use the 10-keys on the keyboard, press the Number Lock key located on the upper left-hand corner of the 10-key pad. The Number Lock LED on the keyboard lights up when the Number Lock is engaged.

→ **Quiet Boot [Enabled]**

Use the **Quiet Boot** BIOS option to select the screen display when the system boots.

- **Disabled** Normal POST messages displayed
- **Enabled** **DEFAULT** OEM Logo displayed instead of POST messages

→ **Launch PXE OpROM [Disabled]**

Use the **Launch PXE OpROM** option to enable or disable boot option for legacy network devices.

- **Disabled** **DEFAULT** Ignore all PXE Option ROMs
- **Enabled** Load PXE Option ROMs.

→ **Option ROM Messages [Force BIOS]**

Use the **Option ROM Messages** option to set the Option ROM display mode.

- **Force BIOS** **DEFAULT** Sets display mode to force BIOS.
- **Keep Current** Sets display mode to current.

→ **UEFI Boot [Disabled]**

Use the **UEFI Boot** option to enable or disable to boot from the UEFI devices.

- **Enabled** Boot from UEFI devices is enabled.
- **Disabled** **DEFAULT** Boot from UEFI devices is disabled.

## IMB-H110 microATX Motherboard

### 5.7 Save & Exit

Use the **Safe & Exit** menu (**BIOS Menu 31**) to load default BIOS values, optimal failsafe values and to save configuration changes.

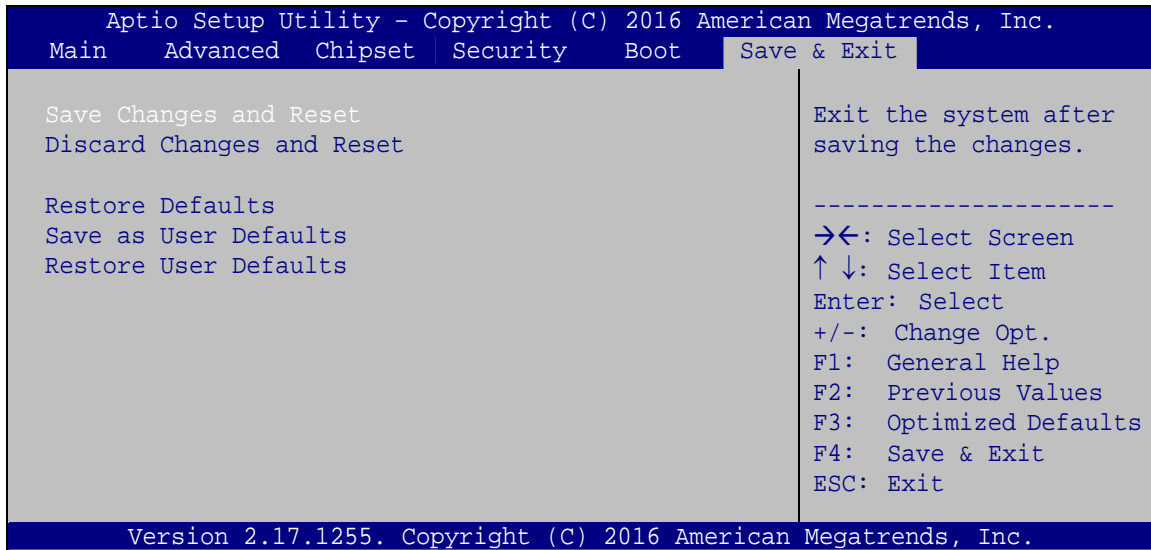

#### BIOS Menu 31: Save & Exit

##### → Save Changes and Reset

Use the **Save Changes and Reset** option to save the changes made to the BIOS options and reset the system.

##### → Discard Changes and Reset

Use the **Discard Changes and Reset** option to exit the system without saving the changes made to the BIOS configuration setup program.

##### → Restore Defaults

Use the **Restore Defaults** option to load the optimal default values for each of the parameters on the Setup menus. **F3 key can be used for this operation.**

##### → Save as User Defaults

Use the **Save as User Defaults** option to save the changes done so far as user defaults.

##### → Restore User Defaults

Use the **Restore User Defaults** option to restore the user defaults to all the setup options.

Appendix

**A**

# Regulatory Compliance

---

### DECLARATION OF CONFORMITY



This equipment has been tested and found to comply with specifications for CE marking. If the user modifies and/or installs other devices in the equipment, the CE conformity declaration may no longer apply.

### FCC WARNING



This equipment complies with Part 15 of the FCC Rules. Operation is subject to the following two conditions:

- This device may not cause harmful interference, and
- This device must accept any interference received, including interference that may cause undesired operation.

This equipment has been tested and found to comply with the limits for a Class A digital device, pursuant to part 15 of the FCC Rules. These limits are designed to provide reasonable protection against harmful interference when the equipment is operated in a commercial environment. This equipment generates, uses, and can radiate radio frequency energy and, if not installed and used in accordance with the instruction manual, may cause harmful interference to radio communications. Operation of this equipment in a residential area is likely to cause harmful interference in which case the user will be required to correct the interference at his own expense.

Appendix

**B**

# Product Disposal

---

## IMB-H110 microATX Motherboard



### CAUTION:

Risk of explosion if battery is replaced by an incorrect type. Only certified engineers should replace the on-board battery.

Dispose of used batteries according to instructions and local regulations.

- Outside the European Union – If you wish to dispose of used electrical and electronic products outside the European Union, please contact your local authority so as to comply with the correct disposal method.
- Within the European Union – The device that produces less waste and is easier to recycle is classified as electronic device in terms of the European Directive 2012/19/EU (WEEE), and must not be disposed of as domestic garbage.

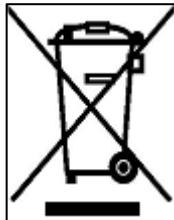

EU-wide legislation, as implemented in each Member State, requires that waste electrical and electronic products carrying the mark (left) must be disposed of separately from normal household waste. This includes monitors and electrical accessories, such as signal cables or power cords. When you need to dispose of your device, please follow the guidance of your local authority, or ask the shop where you purchased the product. The mark on electrical and electronic products only applies to the current European Union Member States.

Please follow the national guidelines for electrical and electronic product disposal.



Appendix

C

# BIOS Options

---

## IMB-H110 microATX Motherboard

Below is a list of BIOS configuration options in the BIOS chapter.

<b>System Date [xx/xx/xx]</b> .....	<b>85</b>
<b>System Time [xx:xx:xx]</b> .....	<b>85</b>
<b>Security Device Support [Disable]</b> .....	<b>86</b>
<b>ACPI Sleep State [S3 (Suspend to RAM)]</b> .....	<b>87</b>
<b>Case Open Beep [Disabled]</b> .....	<b>88</b>
<b>Serial Port [Enabled]</b> .....	<b>89</b>
<b>Change Settings [Auto]</b> .....	<b>89</b>
<b>Serial Port [Enabled]</b> .....	<b>90</b>
<b>Change Settings [Auto]</b> .....	<b>90</b>
<b>Serial Port [Enabled]</b> .....	<b>91</b>
<b>Change Settings [Auto]</b> .....	<b>91</b>
<b>Serial Port [Enabled]</b> .....	<b>92</b>
<b>Change Settings [Auto]</b> .....	<b>92</b>
<b>Serial Port [Enabled]</b> .....	<b>93</b>
<b>Change Settings [Auto]</b> .....	<b>93</b>
<b>Transfer Mode [RS232]</b> .....	<b>94</b>
<b>Serial Port [Enabled]</b> .....	<b>94</b>
<b>Change Settings [Auto]</b> .....	<b>94</b>
<b>Transfer Mode [RS232]</b> .....	<b>95</b>
<b>Parallel Port [Enabled]</b> .....	<b>95</b>
<b>Change Settings [Auto]</b> .....	<b>96</b>
<b>Device Mode [STD Printer Mode]</b> .....	<b>96</b>
<b>Serial Port [Enabled]</b> .....	<b>98</b>
<b>PC Health Status</b> .....	<b>98</b>
<b>CPU_FAN1 Smart Fan Control/SYS_FAN1 Smart Fan Control [Auto Mode]</b> .....	<b>99</b>
<b>Auto mode fan start/off temperature</b> .....	<b>100</b>
<b>Auto mode fan start PWM</b> .....	<b>100</b>
<b>Auto mode fan slope PWM</b> .....	<b>100</b>
<b>Wake system with Fixed Time [Disabled]</b> .....	<b>101</b>
<b>Console Redirection [Disabled]</b> .....	<b>103</b>
<b>Terminal Type [ANSI]</b> .....	<b>103</b>
<b>Bits per second [115200]</b> .....	<b>103</b>
<b>Data Bits [8]</b> .....	<b>103</b>

Parity [None].....	104
Stop Bits [1].....	104
Legacy Serial Redirection Port [COM1].....	105
Hyper-threading [Enabled].....	106
Active Processor Cores [All] .....	106
Intel Virtualization Technology [Disabled] .....	107
Intel(R) SpeedStep(tm) [Enabled].....	107
SATA Controller(s) [Enabled] .....	108
SATA Mode Selection [AHCI].....	108
Hot Plug [Disabled].....	108
Legacy USB Support [Enabled].....	109
Auto Recovery Function [Disabled].....	110
VT-d [Disabled].....	112
Primary Display [Auto] .....	113
DVMT Pre-Allocated [256M] .....	113
DVMT Total Gfx Mem [MAX].....	114
Primary IGFX Boot Display [VBIOS Default] .....	114
Backlight Control Mode [LED(PWM)].....	114
Backlight Control Type [PWM] .....	114
Enable Root Port [Enabled] .....	115
Max Link Speed [Auto] .....	115
Detect Non-Compliance Device [Disabled] .....	115
Restore AC Power Loss [Last State] .....	117
Power Saving Function(ERP) [Disabled].....	117
USB Power SW1 [+5V DUAL].....	118
USB Power SW2 [+5V DUAL].....	118
PCIe Speed [Auto].....	120
Detect Non-Compliance Device [Disabled] .....	120
HD Audio [Auto].....	121
Administrator Password .....	122
User Password .....	122
Bootup NumLock State [On].....	123
Quiet Boot [Enabled] .....	124
Launch PXE OpROM [Disabled].....	124
Option ROM Messages [Force BIOS].....	124

## IMB-H110 microATX Motherboard

UEFI Boot [Disabled] .....	124
Save Changes and Reset .....	125
Discard Changes and Reset .....	125
Restore Defaults .....	125
Save as User Defaults .....	125
Restore User Defaults .....	125

Appendix

**D**

# Terminology

---

## IMB-H110 microATX Motherboard

<b>AC '97</b>	Audio Codec 97 (AC'97) refers to a codec standard developed by Intel® in 1997.
<b>ACPI</b>	Advanced Configuration and Power Interface (ACPI) is an OS-directed configuration, power management, and thermal management interface.
<b>AHCI</b>	Advanced Host Controller Interface (AHCI) is a SATA Host controller register-level interface.
<b>ATA</b>	The Advanced Technology Attachment (ATA) interface connects storage devices including hard disks and CD-ROM drives to a computer.
<b>ARMD</b>	An ATAPI Removable Media Device (ARMD) is any ATAPI device that supports removable media, besides CD and DVD drives.
<b>ASKIR</b>	Amplitude Shift Keyed Infrared (ASKIR) is a form of modulation that represents a digital signal by varying the amplitude (“volume”) of the signal. A low amplitude signal represents a binary 0, while a high amplitude signal represents a binary 1.
<b>BIOS</b>	The Basic Input/Output System (BIOS) is firmware that is first run when the computer is turned on and can be configured by the end user
<b>CODEC</b>	The Compressor-Decompressor (CODEC) encodes and decodes digital audio data on the system.
<b>CMOS</b>	Complimentary metal-oxide-conductor is an integrated circuit used in chips like static RAM and microprocessors.
<b>COM</b>	COM refers to serial ports. Serial ports offer serial communication to expansion devices. The serial port on a personal computer is usually a male DB-9 connector.
<b>DAC</b>	The Digital-to-Analog Converter (DAC) converts digital signals to analog signals.
<b>DDR</b>	Double Data Rate refers to a data bus transferring data on both the rising and falling edges of the clock signal.
<b>DMA</b>	Direct Memory Access (DMA) enables some peripheral devices to bypass the system processor and communicate directly with the system memory.

<b>DIMM</b>	Dual Inline Memory Modules are a type of RAM that offer a 64-bit data bus and have separate electrical contacts on each side of the module.
<b>DIO</b>	The digital inputs and digital outputs are general control signals that control the on/off circuit of external devices or TTL devices. Data can be read or written to the selected address to enable the DIO functions.
<b>EHCI</b>	The Enhanced Host Controller Interface (EHCI) specification is a register-level interface description for USB 2.0 Host Controllers.
<b>EIDE</b>	Enhanced IDE (EIDE) is a newer IDE interface standard that has data transfer rates between 4.0 MBps and 16.6 MBps.
<b>EIST</b>	Enhanced Intel® SpeedStep Technology (EIST) allows users to modify the power consumption levels and processor performance through application software. The application software changes the bus-to-core frequency ratio and the processor core voltage.
<b>FSB</b>	The Front Side Bus (FSB) is the bi-directional communication channel between the processor and the Northbridge chipset.
<b>GbE</b>	Gigabit Ethernet (GbE) is an Ethernet version that transfers data at 1.0 Gbps and complies with the IEEE 802.3-2005 standard.
<b>GPIO</b>	General purpose input
<b>HDD</b>	Hard disk drive (HDD) is a type of magnetic, non-volatile computer storage device that stores digitally encoded data.
<b>ICH</b>	The Input/Output Control Hub (ICH) is an Intel® Southbridge chipset.
<b>IrDA</b>	Infrared Data Association (IrDA) specify infrared data transmission protocols used to enable electronic devices to wirelessly communicate with each other.
<b>L1 Cache</b>	The Level 1 Cache (L1 Cache) is a small memory cache built into the system processor.
<b>L2 Cache</b>	The Level 2 Cache (L2 Cache) is an external processor memory cache.
<b>LCD</b>	Liquid crystal display (LCD) is a flat, low-power display device that consists of two polarizing plates with a liquid crystal panel in between.

## IMB-H110 microATX Motherboard

<b>LVDS</b>	Low-voltage differential signaling (LVDS) is a dual-wire, high-speed differential electrical signaling system commonly used to connect LCD displays to a computer.
<b>POST</b>	The Power-on Self Test (POST) is the pre-boot actions the system performs when the system is turned-on.
<b>RAM</b>	Random Access Memory (RAM) is volatile memory that loses data when power is lost. RAM has very fast data transfer rates compared to other storage like hard drives.
<b>SATA</b>	Serial ATA (SATA) is a serial communications bus designed for data transfers between storage devices and the computer chipsets. The SATA bus has transfer speeds up to 1.5 Gbps and the SATA II bus has data transfer speeds of up to 3.0 Gbps.
<b>S.M.A.R.T</b>	Self Monitoring Analysis and Reporting Technology (S.M.A.R.T) refers to automatic status checking technology implemented on hard disk drives.
<b>UART</b>	Universal Asynchronous Receiver-transmitter (UART) is responsible for asynchronous communications on the system and manages the system's serial communication (COM) ports.
<b>UHCI</b>	The Universal Host Controller Interface (UHCI) specification is a register-level interface description for USB 1.1 Host Controllers.
<b>USB</b>	The Universal Serial Bus (USB) is an external bus standard for interfacing devices. USB 1.1 supports 12Mbps data transfer rates and USB 2.0 supports 480Mbps data transfer rates.
<b>VGA</b>	The Video Graphics Array (VGA) is a graphics display system developed by IBM.



Appendix

**E**

# Digital I/O Interface

---

## IMB-H110 microATX Motherboard

### E.1 Introduction

The DIO connector on the IMB-H110 is interfaced to GPIO ports on the Super I/O chipset. The DIO has both 4-bit digital inputs and 4-bit digital outputs. The digital inputs and digital outputs are generally control signals that control the on/off circuit of external devices or TTL devices. Data can be read or written to the selected address to enable the DIO functions.



#### NOTE:

For further information, please refer to the datasheet for the Super I/O chipset.

---

The BIOS interrupt call **INT 15H** controls the digital I/O.

#### INT 15H:

<b>AH – 6FH</b>	
<u>Sub-function:</u>	
<b>AL – 8</b>	: Set the digital port as INPUT
<b>AL</b>	: Digital I/O input value

## E.2 Assembly Language Sample 1

```
MOV     AX, 6F08H      ;setting the digital port as input
INT     15H            ;
```

AL low byte = value

AH – 6FH
<u>Sub-function:</u>
AL – 9 : Set the digital port as OUTPUT
BL : Digital I/O input value

## E.3 Assembly Language Sample 2

```
MOV     AX, 6F09H      ;setting the digital port as output
MOV     BL, 09H        ;digital value is 09H
INT     15H            ;
```

Digital Output is 1001b

Appendix

**F**

# Watchdog Timer

---



**NOTE:**

The following discussion applies to DOS environment. Contact IEI support or visit the IEI website for specific drivers for other operating systems.

The Watchdog Timer is provided to ensure that standalone systems can always recover from catastrophic conditions that cause the CPU to crash. This condition may have occurred by external EMIs or a software bug. When the CPU stops working correctly, Watchdog Timer either performs a hardware reset (cold boot) or a Non-Maskable Interrupt (NMI) to bring the system back to a known state.

A BIOS function call (INT 15H) is used to control the Watchdog Timer.

INT 15H:

AH – 6FH Sub-function:	
AL – 2:	Sets the Watchdog Timer’s period.
BL:	Time-out value (Its unit-second is dependent on the item “Watchdog Timer unit select” in CMOS setup).

**Table F-1: AH-6FH Sub-function**

Call sub-function 2 to set the time-out period of Watchdog Timer first. If the time-out value is not zero, the Watchdog Timer starts counting down. When the timer value reaches zero, the system resets. To ensure that this reset condition does not occur, calling sub-function 2 must periodically refresh the Watchdog Timer. However, the watchdog timer is disabled if the time-out value is set to zero.

A tolerance of at least 10% must be maintained to avoid unknown routines within the operating system (DOS), such as disk I/O that can be very time-consuming.

## IMB-H110 microATX Motherboard

**NOTE:**

When exiting a program it is necessary to disable the Watchdog Timer, otherwise the system resets.

**EXAMPLE PROGRAM:**

**; INITIAL TIMER PERIOD COUNTER**

;

**W\_LOOP:**

;

```

MOV     AX, 6F02H      ;setting the time-out value
MOV     BL, 30         ;time-out value is 48 seconds
INT     15H

```

;

**; ADD THE APPLICATION PROGRAM HERE**

;

```

CMP     EXIT_AP, 1     ;is the application over?
JNE     W_LOOP        ;No, restart the application

MOV     AX, 6F02H      ;disable Watchdog Timer
MOV     BL, 0         ;
INT     15H

```

;

**; EXIT ;**

Appendix

**G**

# Hazardous Materials Disclosure

---

## IMB-H110 microATX Motherboard

The details provided in this appendix are to ensure that the product is compliant with the Peoples Republic of China (China) RoHS standards. The table below acknowledges the presences of small quantities of certain materials in the product, and is applicable to China RoHS only.

A label will be placed on each product to indicate the estimated “Environmentally Friendly Use Period” (EFUP). This is an estimate of the number of years that these substances would “not leak out or undergo abrupt change.” This product may contain replaceable sub-assemblies/components which have a shorter EFUP such as batteries and lamps. These components will be separately marked.

Please refer to below table.

Part Name	Toxic or Hazardous Substances and Elements					
	Lead (Pb)	Mercury (Hg)	Cadmium (Cd)	Hexavalent Chromium (CR(VI))	Polybrominated Biphenyls (PBB)	Polybrominated Diphenyl Ethers (PBDE)
Housing	O	O	O	O	O	O
Display	O	O	O	O	O	O
Printed Circuit Board	O	O	O	O	O	O
Metal Fasteners	O	O	O	O	O	O
Cable Assembly	O	O	O	O	O	O
Fan Assembly	O	O	O	O	O	O
Power Supply Assemblies	O	O	O	O	O	O
Battery	O	O	O	O	O	O

O: This toxic or hazardous substance is contained in all of the homogeneous materials for the part is below the limit requirement in SJ/T11363-2006 (now replaced by GB/T 26572-2011).

X: This toxic or hazardous substance is contained in at least one of the homogeneous materials for this part is above the limit requirement in SJ/T11363-2006 (now replaced by GB/T 26572-2011).



此附件旨在确保本产品符合中国 RoHS 标准。以下表格标示此产品中某有毒物质的含量符合中国 RoHS 标准规定的限量要求。

本产品上会附有“环境友好使用期限”的标签，此期限是估算这些物质“不会有泄漏或突变”的年限。本产品可能包含有较短的环境友好使用期限的可替换元件，像是电池或灯管，这些元件将会单独标示出来。

部件名称	有毒有害物质或元素					
	铅 (Pb)	汞 (Hg)	镉 (Cd)	六价铬 (CR(VI))	多溴联苯 (PBB)	多溴二苯 醚 (PBDE)
壳体	○	○	○	○	○	○
显示	○	○	○	○	○	○
印刷电路板	○	○	○	○	○	○
金属螺帽	○	○	○	○	○	○
电缆组装	○	○	○	○	○	○
风扇组装	○	○	○	○	○	○
电力供应组装	○	○	○	○	○	○
电池	○	○	○	○	○	○

○: 表示该有毒有害物质在该部件所有物质材料中的含量均在 SJ/T 11363-2006 (现由 GB/T 26572-2011 取代) 标准规定的限量要求以下。

X: 表示该有毒有害物质至少在该部件的某一均质材料中的含量超出 SJ/T 11363-2006 (现由 GB/T 26572-2011 取代) 标准规定的限量要求。